



Innovative Measuring Systems

Innovative Measuring Systems Inc
521 S 48th Street #106
Tempe, Arizona 85281
602-527-5488
www.InnovativeMeasuring.com

Mitutoyo

MeasurLink[®] ENABLED
Data Management Software by Mitutoyo



SPRING PROMO 2021

PRECISION TOOLS & INSTRUMENTS

Effective April 19 through June 30, 2021



SPRING PROMO 2021



The Global Standard for Wireless Connection

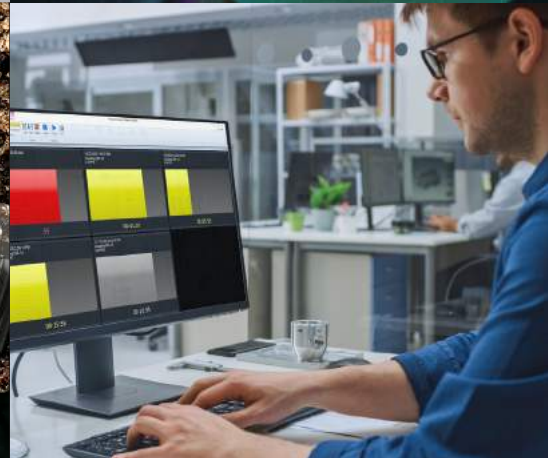
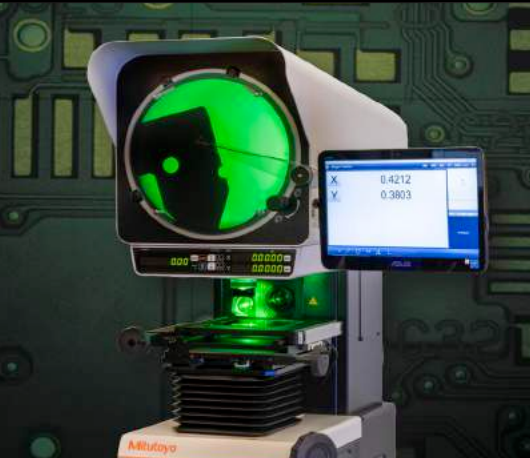

NEW
Products

**NEW FEATURED
PRODUCTS**



Dear Valued Customers,

I want to take a moment to express my sincere appreciation for your continued support and commitment to Mitutoyo products and services.

The 2021 spring promotion offers lots of great deals on NEW products as well as on popular Mitutoyo tools and instruments including data management solutions, calipers, micrometers, linear encoders, indicators, height gages, microscopes, hardness testers and profile projectors. Be sure to take advantage of 10% off on calibrated tools and height gages! Prices are Effective April 19 through June 30, 2021.

You can find all of the latest promotions, products and events on our website, www.mitutoyo.com.

Thank you for trusting us with your metrology needs.

Sincerely,





Matthew B. Dye

Matt Dye
President, Mitutoyo America Corporation

Prices effective April 19 – June 30, 2021



TABLE OF CONTENTS

 Linear Gage/EJ Counters 11	Borematic 3
Mitutoyo is pleased to announce the addition of new Linear Gages and Counters in our contact sensor line. The new EJ Counters have two inputs each which save space, are DIN rail mountable, compact, expandable, and offer output options such as, USB and CC-Link. The LG100 Series Linear Gages have improved specifications such as higher impact resistance, superior ingress protection (IP67G), long life bearings, tighter repeatability and narrow range accuracy, and a reference origin (for position recall).	Holtest 4
 Collection Scheduler 13	Caliper Checker 6
The perfect tool to keep measurements on-time for operators running multiple machines or jobs, the Collection Scheduler timer will reset as soon as measurements have been taken in Real-Time. Supervisors can receive email alerts when measurements miss their assigned schedule or simply keep an eye on the entire shop-floor schedule using Process Manager's new Collection Scheduler view.	Calipers 6
 U-WAVE Bluetooth® 14	Bore Gage 9
U-WAVE is a wireless system that turns any Mitutoyo gage with digimatic output into a wireless keyboard for fast, error-free data collection. U-WAVE transmitters now come in three models: Bluetooth®, Fit and Standard.	Indicators 9
 Surfptest SJ-210 20	Linear Gage/EJ Counter 11
The newly designed Surfptest SJ-210 is a user-friendly surface roughness measurement instrument designed as a handheld tool that can be carried with you and used on-site.	Micrometers 12
 MF/MF-U w/M2 Pkgs 24	Collection Scheduler 13
Mitutoyo is pleased to announce the release of MF microscope packages that include the M2 geometric software and touch screen tablet as well as a retrofit package for D generation MF and MF-U microscopes in the field.	U-WAVE Bluetooth® 14
 PJ-Plus w/M2 Pkgs 26	U-WAVE Fit 15
The Mitutoyo Profile Projector-Plus is a new series of profile projectors that utilize LED lighting and provides reliable measurements in manufacturing site environments. The PJ-Plus is available in packages with the Metlogix M2 software, touch screen tablet with or without edge detection.	Height Gages 16
	Surfptest 20
	Laser Scan Micrometer 21
	Digimatic Scales 22
	DRO 23
	Hardness Testers 23
	Microscopes 24
	Profile Projectors 26
	Calibrated Tools 28

Borematic

Quick, spring-loaded lever action/movement

- > Titanium-coated measuring pins provide excellent durability and impact resistance and allows the instrument to measure close to the bottom of blind holes.
- > Digital display with quick-action lever operation enables quick and easy measurement.
- > Built-in ABSOLUTE System eliminates the need to set the origin point every time the unit is turned on. The system is immune to over-speed errors, thus increasing the reliability of measurement.
- > Digimatic Borematic is compatible with statistical process control systems and measurement support systems.
- > Built-in tolerance judgment function allows GO/NO-GO judgment based on user-defined upper and lower limit settings.

**SAVE
20%**

MeasurLink ENABLED
Data Management Software by Mitutoyo

ABSOLUTE

SPC



Individual Gages: includes one digital display unit and one interchangeable measuring head (plus adapter if required)

Order No	Size Range	Accuracy	Extension Rod	List	Promo
568-461	0.275" - 0.350"	±5µm ±0.00025 in	100mm (952322)	\$1,450.00	\$1,160.00
568-462	0.350" - 0.425"			\$1,450.00	\$1,160.00
568-463	0.425" - 0.500"			\$1,450.00	\$1,160.00
568-464	0.50" - 0.65"	±5µm ±0.00025 in	150mm (952621)	\$1,480.00	\$1,184.00
568-465	0.65" - 0.80"			\$1,480.00	\$1,184.00
568-466	0.8" - 1.0"			\$1,480.00	\$1,184.00
568-467	1.0" - 1.2"	±6µm ±0.0003 in	150mm (952622)	\$1,530.00	\$1,224.00
568-468	1.2" - 1.6"			\$1,700.00	\$1,360.00
568-469	1.6" - 2.0"			\$1,700.00	\$1,360.00
568-470	2.0" - 2.5"			\$1,660.00	\$1,328.00
568-471	2.5" - 3.0"			\$1,720.00	\$1,376.00
568-472	3.0" - 3.5"	±6µm ±0.0003 in	150mm (952623)	\$1,750.00	\$1,400.00
568-473	3.5" - 4.0"			\$1,750.00	\$1,400.00
568-474	4.0" - 4.5"			\$1,830.00	\$1,464.00
568-475	4.5" - 5.0"			\$1,930.00	\$1,544.00

Technical Data

Resolution: 0.001mm or 0.00005 in/0.001mm
 Display: LCD
 Response speed: Infinite
 Battery: SR44 (1 pc), **938882**, for initial operational checks (standard accessory)
 Battery life: Approx. 5,000 hours in continuous use
 Scale type: Electrostatic capacitance absolute encoder

Functions

GO/NO-GO judgment, GO/NO-GO judgment zoom, 2-Point Preset, Zero-setting, Data hold, Error alarm, Low battery voltage alert, Data output, Function Lock, 330° rotary display, inch/mm conversion (inch/mm models)

Complete Unit Gage Sets: includes several individual gages to cover the overall size range of the set

Order No	Overall Range	Range of Individual Gages	Setting Rings	List	Promo
568-965	0.275" - 0.5"	0.275-0.35", 0.35-0.425", 0.425-0.5"	0.35" DIA., 0.425" DIA.	\$5,010.00	\$4,008.00
568-966	0.5" - 1"	0.5-0.65", 0.65-0.8", 0.8-1"	0.65" DIA., 0.8" DIA.	\$5,230.00	\$4,184.00
568-967	1" - 2"	1-1.2", 1.2-1.6", 1.6-2"	1.2" DIA., 1.6" DIA.	\$5,460.00	\$4,368.00
568-968	2" - 3"	2-2.5", 2.5-3"	2.5" DIA.	\$3,910.00	\$3,128.00
568-969	3" - 4"	3-3.5", 3.5-4"	3.5" DIA.	\$4,340.00	\$3,472.00



Interchangeable-Head Sets

Order No	Overall Range	Range of Individual Gages	Setting Rings	List	Promo
568-928	0.275" - 0.5"	0.275-0.35", 0.35-0.425", 0.425-0.5"	0.35" DIA., 0.425" DIA.	\$2,230.00	\$1,784.00
568-929	0.5" - 1"	0.5-0.65", 0.65-0.8", 0.8-1"	0.65" DIA., 0.8" DIA.	\$2,530.00	\$2,024.00
568-930	1" - 2"	1-1.2", 1.2-1.6", 1.6-2"	1.2" DIA., 1.6" DIA.	\$3,080.00	\$2,464.00
568-936	2" - 4"	2-2.5", 2.5-3", 3-3.5", 3.5-4"	2.5" DIA., 3.5" DIA.	\$4,440.00	\$3,552.00



Includes one digital display unit with several interchangeable measuring heads (and adapters as required) to cover the total size range plus one extension rod

Digimatic Holtest

- > TiN-coated measuring contact points provide excellent durability and impact resistance and allows the instrument to measure close to the bottom of blind holes (up to 4"/100mm models).
- > Large LCD readout.
- > Functions available: Presetting, Zero/ABS, Auto power On/Off, Data hold, Data output, Error alarm, Battery replacement alarm.
- > With ratchet stop for constant force.
- > Measure deep holes by attaching an extension rod (optional).
- > Setting rings are included in sets, but optional for individual gages.
- > Supplied in fitted plastic case up to 4"/100mm. Over 4"/100mm supplied in wooden case.
- > Resolution: .00005"/0.001mm (over 4" models: .0001"/0.001mm)



MeasurLink[®] ENABLED
Data Management Software by Mitutoyo

20%
OFF



Digimatic Holtests – Individual Units

Order No.	Range	List	Promo
468-261	Digimatic Holtest, .275" - .35"	\$1,110.00	\$888.00
468-262	Digimatic Holtest, .35" - .425"	\$1,110.00	\$888.00
468-263	Digimatic Holtest, .425" - .5"	\$1,120.00	\$896.00
468-264	Digimatic Holtest, 0.5" - 0.65"	\$1,220.00	\$976.00
468-265	Digimatic Holtest, 0.65" - 0.8"	\$1,220.00	\$976.00
468-266	Digimatic Holtest, 0.8" - 1"	\$1,250.00	\$1,000.00
468-267	Digimatic Holtest, 1.0 - 1.2"	\$1,250.00	\$1,000.00
468-268	Digimatic Holtest, 1.2" - 1.6"	\$1,280.00	\$1,024.00
468-269	Digimatic Holtest, 1.6" - 2.0"	\$1,290.00	\$1,032.00
468-270	Digimatic Holtest, 2" - 2.5"	\$1,400.00	\$1,120.00
468-271	Digimatic Holtest, 2.5" - 3"	\$1,400.00	\$1,120.00
468-272	Digimatic Holtest, 3" - 3.5"	\$1,420.00	\$1,136.00
468-273	Digimatic Holtest, 3.5" - 4"	\$1,440.00	\$1,152.00
468-274	Digimatic Holtest, 4" - 5"	\$1,880.00	\$1,504.00
468-275	Digimatic Holtest, 5" - 6"	\$1,930.00	\$1,544.00
468-276	Digimatic Holtest, 6" - 7"	\$2,050.00	\$1,640.00
468-277	Digimatic Holtest, 7" - 8"	\$2,140.00	\$1,712.00
468-278	Digimatic Holtest, 8" - 9"	\$2,280.00	\$1,824.00
468-279	Digimatic Holtest, 9" - 10"	\$2,330.00	\$1,864.00
468-280	Digimatic Holtest, 10" - 11"	\$2,410.00	\$1,928.00
468-281	Digimatic Holtest, 11" - 12"	\$2,520.00	\$2,016.00

Digimatic Holtests – Interchangeable Head Sets

468-976	Digimatic Holtest Head Set, 0.275" - 0.5"*	\$2,030.00	\$1,624.00
468-977	Digimatic Holtest, Head Set, 0.5" - 0.8"*	\$1,650.00	\$1,320.00
468-978	Digimatic Holtest, Head Set, 0.8" - 2"*	\$4,120.00	\$3,296.00
468-979	Digimatic Holtest, Head Set, 2" - 4"*	\$4,720.00	\$3,776.00
468-980	Digimatic Holtest, Head Set, 4" - 8"*	\$5,540.00	\$4,432.00

Digimatic Holtests – Complete Unit Sets

468-986	Digimatic Holtest, Unit-Set, 0.275" - 0.5"*	\$3,960.00	\$3,168.00
468-987	Digimatic Holtest, Unit-Set, 0.5" - 1"*	\$4,200.00	\$3,360.00
468-988	Digimatic Holtest, Unit-Set, 1" - 2"*	\$4,760.00	\$3,808.00
468-989	Digimatic Holtest, Unit-Set, 2" - 3"*	\$5,350.00	\$4,280.00
468-990	Digimatic Holtest, Unit-Set, 3" - 4"*	\$6,290.00	\$5,032.00

Measuring Deep Holes

An extension rod (optional accessory) can be fitted to provide measurement of deep holes.



VIDEO DEMO



Complete-Unit Set



Interchangeable-Head Set

Holtest

- > Titanium-coated measuring pins provide excellent durability and impact resistance and allows the instrument to measure close to the bottom of blind holes.
- > Three-point design ensures self-centering action for stable measurements in the range above .275" bore diameter.
- > With ratchet stop for constant force.

Holtest Type II

- > The anvils and cone are made from an alloy tool steel with a hardness of HRC60.5 or more.
- > Three-point design ensures self-centering action for stable measurements in the range above .275" bore diameter.
- > With ratchet stop for constant force.

Holtest



Two-point contact type

Holtest Type II



20% OFF

Mechanical Holtests – Individual Units

Order No.	Description/Range	List	Promo
368-021	Holtest, 0.08" - 0.1"	\$1,500.00	\$1,200.00
368-022	Holtest, 0.1" - 0.12"	\$1,500.00	\$1,200.00
368-023	Holtest, 0.12" - 0.16"	\$1,210.00	\$968.00
368-024	Holtest, 0.16" - 0.2"	\$1,210.00	\$968.00
368-025	Holtest, 0.2" - 0.24"	\$1,210.00	\$968.00
368-026	Holtest, 0.24" - 0.28"	\$1,210.00	\$968.00
368-261	Holtest, 0.275" - 0.35"	\$599.00	\$479.20
368-262	Holtest, 0.35" - 0.425"	\$599.00	\$479.20
368-263	Holtest, 0.425" - 0.5"	\$599.00	\$479.20
368-264	Holtest, 0.5" - 0.65"	\$621.00	\$496.80
368-265	Holtest, 0.65" - 0.8"	\$621.00	\$496.80
368-266	Holtest, 0.8" - 1.0"	\$645.00	\$516.00
368-267	Holtest, 1.0" - 1.2"	\$645.00	\$516.00
368-268	Holtest, 1.2" - 1.6"	\$806.00	\$644.80
368-269	Holtest, 1.6" - 2.0"	\$850.00	\$680.00
368-270	Holtest, 2.0" - 2.5"	\$855.00	\$684.00
368-271	Holtest, 2.5" - 3.0"	\$928.00	\$742.40
368-272	Holtest, 3.0" - 3.5"	\$953.00	\$762.40
368-273	Holtest, 3.5" - 4.0"	\$997.00	\$797.60
368-274	Holtest, 4.0" - 5.0"	\$1,280.00	\$1,024.00
368-275	Holtest, 5.0" - 6.0"	\$1,450.00	\$1,160.00
368-276	Holtest, 6.0" - 7.0"	\$1,490.00	\$1,192.00
368-277	Holtest, 7.0" - 8.0"	\$1,540.00	\$1,232.00
368-278	Holtest, 8.0" - 9.0"	\$1,750.00	\$1,400.00
368-279	Holtest, 9.0" - 10"	\$1,960.00	\$1,568.00
368-280	Holtest, 10" - 11"	\$1,980.00	\$1,584.00
368-281	Holtest, 11" - 12"	\$2,030.00	\$1,624.00

Mechanical Holtests – Complete Unit Sets

368-916	Holtest, Set, 0.275" - 0.5"*	\$2,210.00	\$1,768.00
368-917	Holtest, Set, 0.5" - 0.8"*	\$1,490.00	\$1,192.00
368-918	Holtest, Set, 0.8" - 2.0"*	\$3,410.00	\$2,728.00
368-919	Holtest, Set, 2.0" - 4.0"*	\$4,860.00	\$3,888.00
368-920	Holtest, Set, 4.0" - 8.0"*	\$7,440.00	\$5,952.00
368-926	Holtest, 2pc Set, .08" - .12"*	\$3,190.00	\$2,552.00
368-927	Holtest, 4pc Set, .12" - .28"*	\$5,090.00	\$4,072.00
368-995	HOLTEST, SET, TYPE II, R, 0.5 - .8"	\$1,360.00	\$1,088.00
368-996	HOLTEST, SET, TYPE II, R, 0.8 - 2"	\$3,120.00	\$2,496.00
368-997	HOLTEST, SET, TYPE II, R, 2 - 4"	\$4,390.00	\$3,512.00
368-998	HOLTEST, SET, TYPE II, R, 4 - 8"	\$6,840.00	\$5,472.00

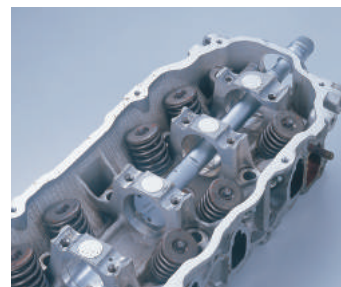

Measuring a Blind Hole

The measuring contact points held in the jaws permit measuring the diameter of a blind hole to the bottom.

(up to 100mm / 4" models)

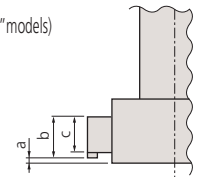

Measuring Deep Holes

An extension tube (optional accessory) can be fitted to enable measurement of deep holes.



TiN coated contact points

Range	a	b	c
6 - 12mm / .275 - .5"	2	—	2.5
12 - 20mm / .5 - .8"	0.3	5.6	3.5
20 - 30mm / .8 - 1.2"	0.3	8.3	5.2
30 - 50mm / 1.2 - 2"	0.3	13	10
50 - 100mm / 2 - 4"	0.3	17	14
100 - 300mm / 4 - 12"	12.4	21	13.8



Inspection Certificate Supplied as Standard

An Inspection Certificate is supplied with each instrument, which assures product quality and safety. On request, Mitutoyo can issue a Calibration Certificate, at a cost, from our accredited calibration laboratory.

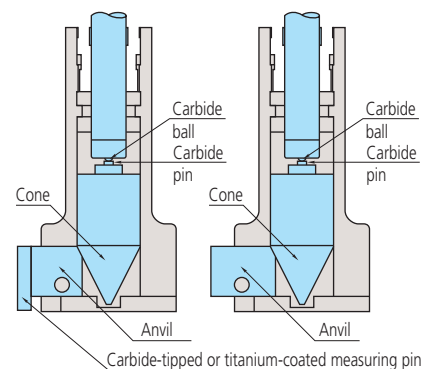

Coolant-Proof Calipers

- Sealed housing is IP-67 rated, meaning it's immune to the coolants, dirt, grit and chips found in many manufacturing environments.
- Easy to use - no need to wipe or clean the scale.
- .0005"/0.01mm resolution with ±.001" accuracy.
- Automatic power-on/off.
- Certificate of Inspection provided.



UP TO 10% OFF



COMPATIBLE WITH
U-WAVE fit

MeasurLink ENABLED
Data Management Software by Mitutoyo

Order No.	Range	List	Promo
Non-Output Style			
500-752-20	0-6"/0-150mm	\$215.00	\$204.25
500-753-20	0-8"/0-200mm	\$288.00	\$273.60
500-754-20*	0-12"/0-300mm	\$499.00	\$474.05
SPC Output Style			
fit 500-762-20	0-6"/0-150mm	\$255.00	\$242.25
fit 500-763-20	0-8"/0-200mm	\$321.00	\$288.90
fit 500-764-20*	0-12"/0-300mm	\$553.00	\$525.35

* ±.0015" accuracy **fit** U-WAVE Fit compatible SPC cable - 1m: **05CZA624** 2m: **05CZA625**



COOLANT PROOF™ IP67

COOLANTPROOF is the universal term of Mitutoyo Digimatic Small Tool Instruments that are free from measurement error and physical deterioration due to routine exposure to water, cutting oil or coolant. This high performance is achieved by using encoders that are inherently immune to contamination, where exposure is inevitable, combined with comprehensive sealing techniques and extremely oil-resistant materials to guarantee a long working life under normal operating conditions.

Digimatic Carbon Fiber Caliper



552-314-10



MeasurLink ENABLED
Data Management Software by Mitutoyo

Order No.	Range	Accuracy	Resolution	List	Promo
552-312-10	0(.5")-18"	+/- .002"	.0005"/0.01mm	\$975.00	\$926.25
552-313-10	0(.5")-24"	+/- .002"	.0005"/0.01mm	\$1,090.00	\$1,035.50
552-314-10	0(1")-40"	+/- .002"	.0005"/0.01mm	\$1,950.00	\$1,852.50
552-315-10	0(1")-60"	+/- .004"	.0005"/0.01mm	\$2,330.00	\$2,213.50
552-316-10	0(1")-80"	+/- .005"	.0005"/0.01mm	\$3,650.00	\$3,467.50

SPC cable - 1m: **05CZA624** 2m: **05CZA625**

- Lightweight Digimatic Calipers that employ CFRP (Carbon Fiber Reinforced Plastics) in the beam and jaws.
- Highly durable and easy to handle.
- Direct readout of ID measurements from the LCD. (Offset value can be set easily by pressing the Offset key.)
- Preset function for setting a desired starting point.
- With SPC data output.
- Special models available with ceramic jaws which are suitable for measuring abrasive and magnetic products.
- Can be used in workshop conditions exposed to coolant, water, dust or oil.
- Incorporates ABSOLUTE measurement system.
- Automatic power-on/off.



CERA Caliper Checker



33% OFF

Order No.	Range	Remarks (length to check)	List	Promo
515-565	0 - 12"	Outside measurement: 1", 2", 4", 6", 8", 10", 12" Inside measurement: 1", 2", 4", 6", 8", 10", 12"	\$4,520.00	\$2,999.00

Prices effective April 19 - June 30, 2021

CERA Caliper Checker

- Permanently wrung, high grade CERA gage blocks in a protective metal casing.
- Stands perpendicular for height gage inspection.
- * Also includes same features as CERA Gage Blocks

CERA (Zirconia Ceramic) Gage Blocks*

- Extremely high wear resistance, 3x better than carbide.
- Corrosion proof - no oil needed.
- Closest expansion coefficient to steel.
- Anti-magnetic - keeps away steel dust.
- High wringing force due to high density.
- Crack and burr resistant.
- Low thermal conductivity - excellent dimensional stability under brief temperature changes (from handling, etc.).

Digimatic Calipers

UP TO 10% OFF

- > AOS Electromagnetic inductive sensor improves environmental resistance against dirt, water and oil.
- > A battery life of approximately 3.5 years has been achieved under normal use through the adoption of Mitutoyo's ABSOLUTE scale.
- > The slider configuration features an ergonomic, thumb-friendly shape.
- > Step-measurement capable.
- > The data output function allows integration into Statistical Process Control and measurement systems.
- > Display character height: 9mm
- > AOS applies to 4", 6" and 8" models
- > Resolution: .0005"/0.01mm



www.mitutoyo.com/aoscd
VIDEO DEMO

MeasurLink ENABLED
Data Management Software by Mitutoyo



500-171-30



AOS: Advanced Onsite Sensor

Order No.	Range	Remarks	List	Promo
No SPC Output Style				
500-195-30	0-4"/0-100mm	.075" round depth bar	\$148.00	\$140.60
500-196-30	0-6"/0-150mm		\$161.00	\$152.95
500-197-30	0-8"/0-200mm		\$231.00	\$219.45
500-193-30	0-12"/0-300mm		\$464.00	\$440.80
With SPC Output Style				
fit 500-170-30	0-4"/0-100mm	.075" round depth bar	\$177.00	\$168.15
fit 500-171-30	0-6"/0-150mm		\$188.00	\$178.60
fit 500-172-30	0-8"/0-200mm		\$248.00	\$223.20
fit 500-173-30	0-12"/0-300mm		\$541.00	\$513.95
500-505-10	0-18"/0-450mm	without thumb roller	\$844.00	\$801.80
500-506-10	0-24"/0-600mm	without thumb roller	\$927.00	\$880.65
500-507-10	0-40"/0-1000mm	without thumb roller	\$1,790.00	\$1,700.50

fit U-WAVE Fit compatible

SPC cable with data switch - 1m: 959149 2m: 959150

Dial Caliper



505-742-56

UP TO 10% OFF

- > Smooth sliding with high shock protection.
- > Lock screw for dial bezel and for holding the sliding jaw position.
- > Can measure OD, ID, depth and steps.
- > Models available with carbide-tipped OD and ID jaws.

Order No.	Range	Remarks	List	Promo
505-742	0-6" .100"/rev		\$125.00	\$118.75
505-738	0-6" .100"/rev	carbide-tipped jaws	\$213.00	\$202.35
505-740	0-6" .200"/rev		\$114.00	\$108.30
505-743	0-8" .100"/rev		\$182.00	\$163.80
505-746	0-12" .100/rev		\$289.00	\$260.10
505-749	0-12" .200/rev		\$269.00	\$255.55
505-742-56	0-6" .100"/rev	black dial face	\$125.00	\$112.50

Offset Caliper

- > Main scale jaw can slide up and down to facilitate measurement of stepped sections. (Hard-to-reach dimensions such as A, B, C can be accurately measured.)
- > With depth bar.
- > With SPC data output.

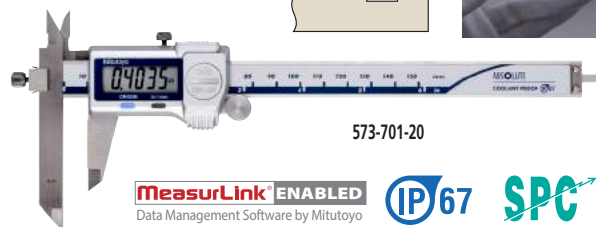
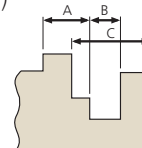

573-701-20

MeasurLink ENABLED
Data Management Software by Mitutoyo



Order No.	Range	Accuracy	Resolution	List	Promo
fit 573-701-20	0-6" / 0-150mm	±.001"	.0005" / 0.01mm	\$478.00	\$454.10
fit 573-702-20	0-8" / 0-200mm	±.001"	.0005" / 0.01mm	\$548.00	\$520.60
fit 573-704	0-12" / 0-300mm	±.0015"	.0005" / 0.01mm	\$735.00	\$698.25

fit U-WAVE Fit compatible SPC cable with data switch - 1m: 05CZA624 2m: 05CZA625

Point Caliper

- > Narrow tip jaws fit into very small grooves and tracks, making many previously difficult outside measurements easier to achieve.
- > With depth bar.
- > With SPC data output.

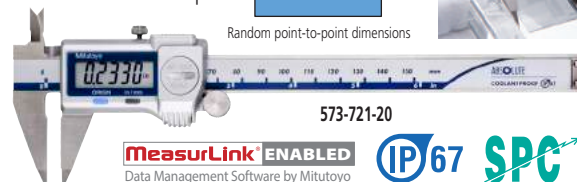
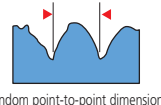

573-721-20

MeasurLink ENABLED
Data Management Software by Mitutoyo



Order No.	Range	Accuracy	Resolution	List	Promo
fit 573-721-20	0-6" / 0-150mm	±.001"	.0005" / 0.01mm	\$419.00	\$398.05
fit 573-725-20*	0-6" / 0-150mm	±.001"	.0005" / 0.01mm	\$520.00	\$494.00

* Extended tips **fit** U-WAVE Fit compatible SPC cable with data switch - 1m: 05CZA624 2m: 05CZA625

Low-Force Caliper

- > Due to the low measuring force, these calipers are ideal for elastic or resilient workpieces such as plastic parts and rubber parts that standard calipers can't measure consistently.
- > With SPC data output.



573-291-30

MeasurLink ENABLED
Data Management Software by Mitutoyo



Order No.	Range	Accuracy	Resolution	List	Promo
fit 573-291-30	0-7" / 0-180mm	±.002"	.0005" / 0.01mm	\$845.00	\$802.75

fit U-WAVE Fit compatible

www.mitutoyo.com

Calculation-Type Digimatic Indicator ID-C

- > The ABSOLUTE Digimatic indicator performs internal calculations using the formula $Ax+B+Cx-1$ (assuming spindle displacement as x), while the specified coefficients A, B and C can be set with respect to the purpose of measurement or dimensions of the fixtures. This unique feature allows for reading measurements directly, without searching for conversions.
- > Calculation-Type Digimatic Indicator features both a key lock and parameter lock.
- > Fast measurement frequency up to 50 per second.
- > An analog bar provides easy-to-read values when scanning for Max, Min and TIR Values.

- > Improved parameter setting software makes it even easier to set all of the available parameters and determine and upload the proper coefficients for calculation. (optional) **21EZA313**



MeasurLink[®] ENABLED
Data Management Software by Mitutoyo



www.mitutoyo.com/idccal
VIDEO DEMO

10% OFF



ABSOLUTE[®]

Stem dia. 3/8" #4-48 UNF Thread

Order No.	Resolution	Range	Accuracy	Measuring Force	List	Promo
543-342B	.00005/.0001/.0005" (0.001/0.01mm) Selectable	.5"/12.7mm	±.00010"/0.003mm	1.5N or less	\$458.00	\$412.20

SPC cable – 1m: **905338** 2m: **905409**



Installed on optional bore gage probe (page 9)

Bore Gage ABSOLUTE Digimatic Indicator ID-C

- > Hold automatically picks up hole diameter after a sweep.
- > Bore Gage Digimatic Indicator features both a key lock and parameter lock.
- > Fast measurement frequency up to 50 per second.
- > An analog bar indicator is integrated to enhance the intuition in reading.
- > Up to three sets of master values and upper/lower tolerance values can be memorized.

- > GO/NO-GO judgment
- > Employing the ABSOLUTE linear encoder, the ID-C always displays the spindle Absolute Position from the origin at power-on.
- > Improved parameter setting software makes it even easier to set all of the available parameters and determine and upload the proper coefficients for calculation. (optional) **21EZA313**

MeasurLink[®] ENABLED
Data Management Software by Mitutoyo

10% OFF



ABSOLUTE[®]

Order No.	Resolution	Range	Accuracy	Measuring Force	List	Promo
543-312B	.00005/.0001/.0005" (0.001/0.01mm) Selectable	.5"/12.7mm	±.00010"/0.003mm	1.5N or less	\$458.00	\$412.20

SPC cable – 1m: **905338** 2m: **905409**

Peak Hold ABSOLUTE Digimatic Indicator ID-C

With Max./Min. Value Holding Function

- > Peak Hold Digimatic Indicator features both a Key Lock and Parameter Lock.
- > An analog bar provides easy-to-read values when scanning for Max, Min and TIR Values.
- > GO/NO-GO judgment
- > The maximum, minimum or runout value can be displayed during measurement.

- > Fast measurement frequency up to 50 per second.
- > Employing the ABSOLUTE linear encoder, the Signal ID-C always displays the spindle Absolute Position from the origin at power-on.
- > Improved parameter setting software makes it even easier to set all of the available parameters and then determine and upload the proper coefficients for calculation. (optional) **21EZA313**

15% OFF



ABSOLUTE[®]

Order No.	Resolution	Range	Accuracy	Remarks	List	Promo
Stem dia. 3/8", #4-48 UNF Thread						
543-302	.00005/.0001/.0005" 0.001/0.01mm	.5"/12.7mm	±.00010"/0.003mm	w/lug	\$458.00	\$389.30
543-302B	Selectable	.5"/12.7mm	±.00010"/0.003mm	Flat-back	\$458.00	\$389.30

SPC cable – 1m: **905338** 2m: **905409**

MeasurLink[®] ENABLED
Data Management Software by Mitutoyo

Prices effective April 19 – June 30, 2021

ABSOLUTE Digimatic Indicator ID-S

- > Employing the ABSOLUTE linear encoder, the ID-S always displays the spindle Absolute Position from the origin at power-on. Also, unlimited response speed eliminates overspeed errors.
- > Dust/Water protection level: IP42 (IP53: **543-795B, 543-796B**)
- > SPC data output.



MeasurLink ENABLED
Data Management Software by Mitutoyo



Order No.	Resolution	Range	Accuracy	Measuring force	Remarks	List	Promo
Stem dia. 3/8", #4-48 UNF Thread							
543-783	.0005"/0.01mm	.5" / 12.7mm	±.0010"	1.5N or less	w/ lug back	\$182.00	\$172.90
543-783B	.0005"/0.01mm	.5" / 12.7mm	±.0010"	1.5N or less	w/ flat-back	\$182.00	\$172.90
Stem ø 8mm, M2.5 x 0.45 Thread							
543-782	.0005"/0.01mm	.5" / 12.7mm	±.001"	1.5N or less	w/ lug back	\$182.00	\$172.90
543-782B	.0005"/0.01mm	.5" / 12.7mm	±.001"	1.5N or less	w/ flat-back	\$182.00	\$172.90

SPC cable – 1m: **905338** 2m: **905409**

ID-C Digimatic Indicators

- > ABSOLUTE Encoder ensures all settings and readings maintained for the life of the battery (even when the power is turned off).
- > Preset, zero set, inch/mm, +/- direction and GO/NO-GO functions.
- > Face rotates 330° for use at various angles.
- > Stem diameter: 3/8".
- > Protected from overspeed errors.
- > SPC output provided.
- > Average battery life 7,000 hours using SR-44 battery (938882).

MeasurLink ENABLED
Data Management Software by Mitutoyo

UP TO 10% OFF



Now with multiplier function $f(x)=Ax$
(other models available with $Ax+B+Cx-1$ function)

Order No.	Range	Remarks	List	Promo
.0005"/0.01mm Resolution				
543-402	.500"/12.7mm	lug back	\$319.00	\$303.05
543-402B	.500"/12.7mm	flat back	\$319.00	\$287.10
543-476B	1"/25mm	flat back	\$468.00	\$444.60
543-496B	2"/50mm	flat back	\$615.00	\$584.25
.00005"/.0001"/.0005"/0.001mm/0.01mm selectable resolutions				
543-472B	1"/25mm	flat back	\$585.00	\$555.75
543-492B	2"/50mm	flat back	\$734.00	\$697.30

SPC cable – 1m: **905338** 2m: **905409**

Bore Gages

- > Carbide-tipped contact points for durability.
- > The dial indicator is fully protected by a rugged cover.
- > Optional extension rods can be attached for measuring deep holes.



See Digimatic indicators made specifically for bore gages (page 8)



511-751

Order No.	Range	Anvils	Spacers	List	Promo
511-751	.7 - 1.4"	9	2	\$423.00	\$380.70
511-752	1.4 - 2.5"	6	4	\$413.00	\$371.70
511-753	2.0 - 6.0"	11 (2" sub anvil)	4	\$451.00	\$405.90
511-754	4.0 - 6.5"	13	4	\$596.00	\$536.40
511-755	6.5 - 10"	6	7	\$672.00	\$604.80
511-756	10 - 16"	5 (3" sub anvil)	7	\$799.00	\$719.10

www.mitutoyo.com



Digimatic Indicator ID-H

Remote Programming Capable

> This digital indicator offers the excellent accuracy and functionality expected from this class of indicator. Take advantage of its high accuracy backed up by 0.5µm / .00002" resolution, remote control functionality via a handheld controller (or an RS-232C interface) and easy runout measurements with the well-established analog bar display.

> The maximum, minimum or runout value can be displayed during measurement.
 > GO/NO-GO judgment is performed by setting the upper and lower tolerances. If a judgment result is out of tolerance, the display backlighting changes from green to red, so tolerance judgment can be made at a glance.
 > With RS-232C input/output

Stem dia. 3/8" #4-48 UNF Thread

Order No.	Resolution	Range	Model	Accuracy	List	Promo
543-562A	.00002", .00005", .0001", 0.0005mm, 0.001mm	1.2" / 30.4mm	ID-H530E	0.0015mm	\$909.00	\$818.10
543-564A	0.001mm	2.4" / 60.9mm	ID-H560E	0.0025mm	\$1,080.00	\$972.00

SPC cable – 1m: 936937 2m: 965014

10% OFF

21EZA099 Remote controller (optional)



543-564A



MeasurLink ENABLED
Data Management Software by Mitutoyo

ABSOLUTE Digimatic Indicator ID-F

> With the ABSOLUTE linear encoder technology, once the measurement reference point has been preset, it will not be lost when the power is turned on.
 > GO/NO-GO judgment is performed by setting the upper and lower tolerances. If a judgment result is out of tolerance, the display backlighting changes from green to red, so tolerance judgment can be made at a glance.
 > The maximum, minimum or runout value can be displayed during measurement.

> An analog bar indicator has been integrated to handle upper/lower limit approaching and zero approaching. It enhances the ease of operation in the same manner as a dial indicator. The display range of the analog bar can be changed.



10% OFF



543-552A



543-558A



ABSOLUTE®

MeasurLink ENABLED
Data Management Software by Mitutoyo

Stem dia. 3/8" #4-48 UNF Thread

Order No.	Resolution	Range	Model	Accuracy	List	Promo
543-552A	.00005", .0001", .0005", .001", 0.001mm, 0.01mm	1" / 25.4mm	ID-F125E	.00012"	\$687.00	\$618.30
543-558A	0.01mm	2" / 50.8mm	ID-F150HE	.00012"	\$796.00	\$716.40

SPC cable – 1m: 936937 2m: 965014

ABSOLUTE Digimatic Indicator ID-U

> Slim digital indicator with low price.
 > Large LCD and simple key operation.
 > After the initial origin setting, the ID-U no longer needs absolute positioning over the entire battery life; the origin is remembered even after power-off.
 > Ideal for installation into measuring devices because of compact design and long battery life.
 > Employing the ABSOLUTE linear encoder, the ID-U always displays the spindle Absolute Position from the origin at power-on. Also unlimited response speed eliminates overspeed errors.
 > Flat-back type has no option for backs.

10% OFF



575-123

ABSOLUTE®
SPC

MeasurLink ENABLED
Data Management Software by Mitutoyo

Order No.	Resolution	Range	Model	Accuracy	Measuring force	List	Promo
575-123	.0005"/0.01mm	1" / 25.4mm	ID-U1025E	.0008"	1.8N or less	\$201.00	\$180.90

SPC cable – 1m: 905338 2m: 905409

Prices effective April 19 – June 30, 2021

EJ Series Industrial interface-mounted compact counter



Compact size and easy to use

Up to 8 compact counters (EJ counters) can be linked providing the capacity to connect up to 16 gages. On a DIN rail, each unit can be connected directly without using cables, so it takes up minimal space. All linked units and gages can be driven by a single power source.

CC-Link connection, USB connection

Data can be output through an industrial interface (CC-Link) by linking a compact counter (EJ counter) with an interface unit. Constant data monitoring and positional management are performed. A USB interface is also provided for easy connection with a computer.

Note: The range of interfaces is set to be expanded in the near future.

Calculation function

Enables sum difference operations between 2 gages connected to the same counter. Functions such as tolerance judgment and peak hold are also included.



Order No	Description	List	Promo
542-081	Main EJ Module Counter	\$475.00	\$451.25
542-081A	Main EJ Module w/AC Components	\$550.00	\$522.50
21HZA149	USB only interface	\$349.00	\$331.55
21HZA186	CC-Link Module (Mitsubishi), and USB	\$775.00	\$736.25

Linear Gage LG100 Series



IP67 G

Order No	Description	List	Promo
542-190	LG100-110, Range: .4"/10mm, Res: .00005"/1μm	\$550.00	\$522.50
542-193	LG100-125, Range: 1"/25mm, Res: .00005"/1μm	\$700.00	\$665.00
542-196	LG100-150, Range: 2"/50mm, Res: .00005"/1μm	\$850.00	\$807.50
542-191	LG100-0510, Range: .4"/10mm, Res: .00002"/0.5μm	\$600.00	\$570.00
542-194	LG100-0525, Range: 1"/25mm, Res: .00002"/0.5μm	\$750.00	\$712.50
542-197	LG100-0550, Range: 2"/50mm, Res: .00002"/0.5μm	\$900.00	\$855.00
542-192	LG100-0110, Range: .4"/10mm, Res: 5μinch/0.1μm	\$650.00	\$617.50
542-195	LG100-0125, Range: 1"/25mm, Res: 5μinch/0.1μm	\$800.00	\$760.00

Adapters

Order No	Description	List
21HZA193	ADAPTER - LG NO ORIGIN - 6 PIN LG TO 10 PIN EJ COUNTER	\$80.00
21HZA194	ADAPTER - LG W/ORIGIN - 8 PIN LG TO 10 PIN EJ COUNTER	\$80.00
21HZA195	ADAPTER - LG NO ORIGIN - 10 PIN LG TO 6 PIN COUNTER	\$60.00
21HZA196	ADAPTER - LG W/ORIGIN - 10 PIN LG TO 8 PIN COUNTER	\$70.00

High accuracy

Precision and accuracy demanded by the automated assembly and inspection markets, are guaranteed. Due to our expertise as a manufacturer of measuring instruments, repeatability in the full measurement range (2σ) and narrow-range precision are also guaranteed.

Environment resistance

Sliding durability of more than 50 million cycles*, with protection level of IP67G. A highly oil-resistant material is used in the rubber cap and cable sheath, so it can be used even in harsh environments.

* 10 mm range models (Actual value from in-house tests)

Reference point detection

Reference point signal output functions are featured throughout this series. When incorporating into a device the master setting value is easy to set and is retained after shutdown.

LG QuickSetup Tool

A configuration tool is FREE for use with the EJ counter when connected via the optional USB interface. Multiple settings normally carried out with counter operating keys can now be easily applied from a computer. Live displays allow for easily viewing gage positions or measurements at a glance.

Note: This software can be used free of charge and downloaded from the Mitutoyo website. <https://www.mitutoyo.co.jp/eng/contact/products/lg/>

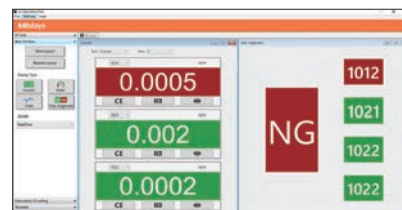

Quickmikes

The new Quickmike series still boasts the super-fast spindle feed rate that's **20x faster** than standard micrometers.

- IP65 protection – can be used around cutting fluids
- > MIN Hold – the minimum measurement can be held on the display for more repeatable and accurate measurements
- > Larger LCD – 33% larger, 10mm character height
- > Function lock – prevents accidental changes
- > 5 year battery life – more operating time, less downtime looking for and replacing batteries
- > Non-rotating spindle



293-676-20

ABSOLUTE™ SPC

COOLANT PROOF™ IP65

MeasurLink® ENABLED
Data Management Software by Mitutoyo



Order No.	Range	Resolution	Accuracy	Flatness	Parallelism	List	Promo
293-676-20	0 - 1.2"	.00005"/0.001mm	±0.0001"	0.000012"	0.00008"	\$611.00	\$580.45
293-677-20	1 - 2.2"	.00005"/0.001mm	±0.0001"	0.000012"	0.00008"	\$667.00	\$633.65

SPC cable with data switch – 1m: 05CZA662 2m: 05CZA663

MDC-Lite Micrometer

- > Provided only with zero set and in/mm (inch/metric models only) keys.
- > A ratchet stop or friction thimble for a constant measuring force.
- > Measurement readout with large characters on the LCD.
- > No spindle clamp. No data output.

Order No.	Range	Resolution	Remarks	List	Promo
293-831-30	0 - 1" / 0 - 25.4mm	.00005" / 0.001mm	Ratchet Stop	\$155.00	\$147.25
293-832-30	0 - 1" / 0 - 25.4mm	.00005" / 0.001mm	Friction Thimble	\$165.00	\$156.75



293-831-30

Digimatic Micrometer

- > New electromagnetic ABSOLUTE sensor - Improved resistance to environmental conditions such as dirt, oil and water, which can cause false readings.
- > New ratchet thimble on select models improves one-hand operability.
- > New anti-slip finish for improved grip while taking measurements.
- > Long battery life – 2.4 years under normal operation.
- > Fully compatible with existing Mitutoyo Digimatic peripherals (SPC Cables, U-WAVE wireless transmitters, DP1-VA, etc.) – SPC output-enabled IP65 models.
- > Function-lock system prevents inadvertent setting changes.
- > Certificate of Inspection provided.

UP TO 10% OFF



293-330-30

IP65



www.mitutoyo.com/MDC VIDEO DEMO



COOLANT PROOF™

MeasurLink® ENABLED
Data Management Software by Mitutoyo

	Order No.	Range	Resolution	Remarks	List	Promo
fit	293-330-30*	0-1"/0-25.4mm	.00005"/0.001mm	Ratchet Stop	\$247.00	\$234.65
	293-340-30	0-1"/0-25.4mm	.00005"/0.001mm	Ratchet Stop	\$193.00	\$183.35
	293-344-30	0-1"/0-25.4mm	.00005"/0.001mm	Ratchet Thimble	\$193.00	\$183.35
	293-349-30	0-1"/0-25.4mm	.0001"/0.001mm	Ratchet Thimble, tenths reading	\$193.00	\$183.35
fit	293-331-30*	1-2"/25.4-50.8mm	.00005"/0.001mm	Ratchet Stop w/Standard	\$291.00	\$261.90
	293-341-30	1-2"/25.4-50.8mm	.00005"/0.001mm	Ratchet Stop w/Standard	\$250.00	\$237.50
	293-345-30	1-2"/25.4-50.8mm	.00005"/0.001mm	Ratchet Thimble w/Standard	\$250.00	\$237.50
fit	293-334-30*	0-1"/0-25.4mm	.00005"/0.001mm	Ratchet Thimble	\$265.00	\$251.75
fit	293-335-30*	0-1"/0-25.4mm	.00005"/0.001mm	Friction Thimble	\$247.00	\$234.65



*with SPC Output

fit U-WAVE Fit compatible

SPC cable with data switch – 1m: 05CZA662 2m: 05CZA663

Purchase the world's first 5µinch /0.1µm resolution micrometer and receive a USB input tool and cable (\$280 value)

Using precision digital measuring tools together with a USB input tool improves both measurement results and data reliability. The latest version of Digimatic output, d2, allows output to a resolution of 1 millionths of an inch. The high-accuracy MDH with 5 millionths resolution can output in its entirety in both inch and metric. Resulting data can input directly to Excel®, MeasurLink® or other SPC programs.

To receive this special offer, use promo code: **PROMO026**.

> Range: 0-1", Resolution: .000005", Accuracy: +/- .000020

Part #	Description	List Price
PROMO026	Package: MDH Mic, SPC Cable, USB Input Tool	\$1,680.00
293-130-10	MDH Micrometer with high accuracy, high resolution output	\$1,680.00
05CZA662	SPC CONNECTING CABLE (1M)	\$83.80
264-016-10	USB INPUT TOOL	\$197.00



Collection Scheduler

Keep critical measurements on track with MeasurLink® Collection Scheduler. For customers that manufacture and measure on a timed schedule, Collection Scheduler will alert operators when the next measurement is due. Working in combination with any MeasurLink® Real-Time edition, it is the perfect tool to keep measurements on-time and productivity high for operators running multiple machines or jobs. **Add to any MeasurLink® workgroup.**

Supervisors can receive email alerts when measurements miss their assigned schedule or simply keep an eye on the entire shop-floor schedule using Process Manager's new Collection Scheduler view.



MeasurLink®
An Integrated Solution for Quality Data Management

www.measurlink.com

Features & Benefits

Colorful Andon Display

Run tiles turn red or yellow if schedules are due or about to be due to help operators easily recognize when measurements need to occur.

Customized Schedules

Set schedules for each day or shift to suit organizational needs.

Auto-switch between modules

Select the run due for measurement and automatically launch it in Real-Time. Suspend the run and automatically return to Collection Scheduler for easy operation.

Customizable Layout

Set the size and layout of the run tiles to make easy identification when managing multiple runs.

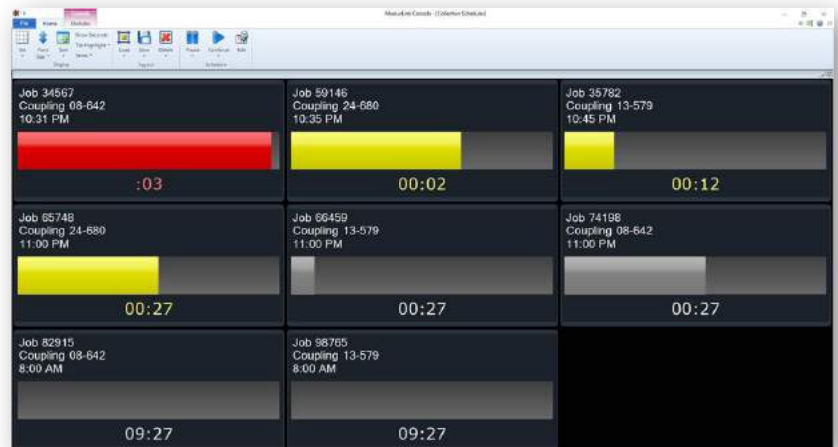

Order No.	Description	List	Promo
64AAB675	COLLECTION SCHEDULER V9	\$1,025.00	\$973.75

www.mitutoyo.com

U-WAVE is a wireless system that turns any Mitutoyo gage with digimatic output into a wireless keyboard for fast, error-free data collection. U-WAVE transmitters now come in three models: Bluetooth®, Fit and Standard. Send data with a push of a button or request it from the PC or mobile device.



U-WAVE Bluetooth®

U-WAVE-TMB/TCB

The new U-WAVE Bluetooth® transmitter features:

- > Now utilizes the popular Bluetooth® 4.2 Low Energy Wireless Technology.
- > This new Bluetooth® version of U-WAVE allows a simple connection to smartphones, tablets and Bluetooth® enabled Laptops and PC's.
- > The same low profile and ergonomic fit benefits of the U-WAVE Fit.
- > A buzzer type and IP67 type with dustproof and waterproof specifications are available.
- > Up to 7 units can be connected to 1 Bluetooth® enabled PC without a receiver.
- > New U-WAVEpak for Android, iOS and Windows available at no cost.



Request an assessment to determine how quickly your company can obtain a full ROI

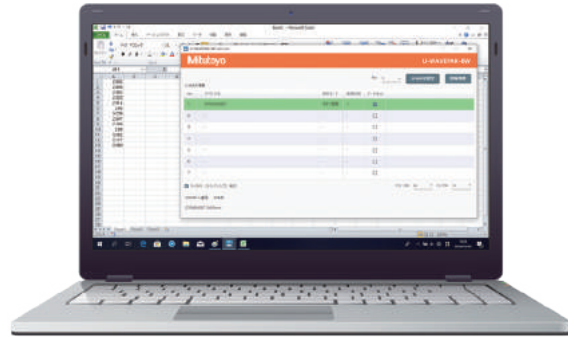
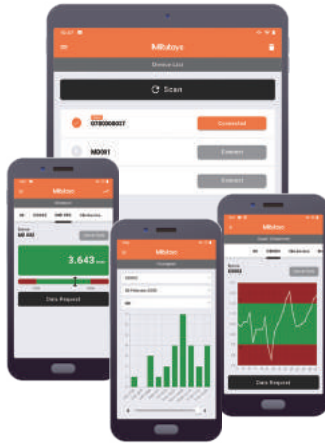

The measurement data is used to make the software in the pc Transferable PC Communication Software U-WAVEPAK-BW.

The Google Play and Google Play logos are trademarks of Google LLC. The Apple and Apple logos are trademarks of Apple Inc.



U-WAVE-TMB



Data Management Software by Mitutoyo



U-WAVE-TCB



10% OFF

U-WAVE-TMB/TCB*

Order No.	Model	Measuring Instrument*	Remarks	List	Promo
264-624	U-WAVE-TCB	4", 6", 8", 12" IP67 caliper/standard caliper	IP67/LED	\$190.00	\$171.00
264-625	U-WAVE-TCB	4", 6", 8", 12" IP67 caliper/standard caliper	Buzzer/LED	\$190.00	\$171.00
264-626	U-WAVE-TMB	COOLANT-PROOF (IP65) micrometer	IP67/LED	\$190.00	\$171.00
264-627	U-WAVE-TMB	COOLANT-PROOF (IP65) micrometer	Buzzer/LED	\$190.00	\$171.00
02AZF310	Connection unit	IP67 caliper/COOLANT-PROOF (IP65) micrometer	Waterproof	\$70.00	\$63.00
02AZF300	Connection unit	Standard caliper	Standard	\$70.00	\$63.00

* No U-WAVE Receiver required

Prices effective April 19 – June 30, 2021

U-WAVE Wireless Data Transmitters

The new Mitutoyo U-WAVE Fit wireless data transmitter fits to the back of popular Mitutoyo hand-held measuring instruments. This new design allows for a snug fit behind the display resulting in a more ergonomic feel. U-WAVE Fit is the same technology as the U-WAVE T, just a smaller version.

U-WAVE fit

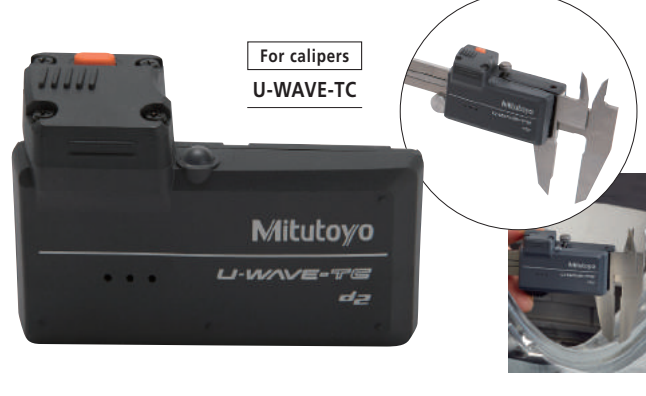

U-WAVE-TM for micrometers and U-WAVE-TC for calipers are available both as, the buzzer and water/dust-proof IP67 types. The buzzer type notifies the normal reception of data by LED and buzzer sound. The water/dust-proof IP67 type is designed for harsh environments and therefore, is only equipped with LED notification of data reception.

MeasurLink ENABLED
Data Management Software by Mitutoyo

10% OFF

U-WAVE-Fit (Transmitter)

Order No.	Model	Measuring Instrument*	Remarks	List	Promo
264-620	U-WAVE-TC	4", 6", 8", 12" IP67 caliper/standard caliper	IP67/LED	\$190.00	\$171.00
264-621	U-WAVE-TC	4", 6", 8", 12" IP67 caliper/standard caliper	Buzzer/LED	\$190.00	\$171.00
264-622	U-WAVE-TM	COOLANT-PROOF (IP65) micrometer	IP67/LED	\$190.00	\$171.00
264-623	U-WAVE-TM	COOLANT-PROOF (IP65) micrometer	Buzzer/LED	\$190.00	\$171.00
02AZF310	Connection unit	IP67 caliper/COOLANT-PROOF (IP65) micrometer	Waterproof	\$70.00	\$63.00
02AZF300	Connection unit	Standard caliper	Standard	\$70.00	\$63.00

* Please contact Mitutoyo or distributor for further details

U-WAVE-R (Receiver)

Order No.	Remarks	Software	Number of U-WAVE-R units that can be connected to PC	Number of U-WAVE-T units that can be connected	List	Promo
02AZD810D	U-WAVE-R + software	U-WAVE PAK	Up to 15	Up to 100	\$499.00	\$449.10

- The transmitter is designed to fit in the space behind the display, and the connecting cable has been replaced by a rigid connector
- Approx. 20 m transmission range (within visible range)
- 2.4GHz wireless system for reliable and secure data transmission
- Easy data export to Microsoft® Excel® or SPC software applications
- Transmitter confirms data transfer by an LED signal and optional buzzer
- An IP67 transmitter is available to ensure a coolant-proof gaging system
- Low power consumption: 400,000 data transmissions with a single battery

Standard U-WAVE Wireless System

MeasurLink ENABLED
Data Management Software by Mitutoyo

U-WAVE is a wireless system that connects to a gage with SPC output. The data is sent to a receiver that is connected to a PC through a USB connection.

- > 2.4 GHz ZigBee wireless with a 60ft range.
- > HID compatible (Keyboard Entry) and Serial (VCP).
- > Supports Mitutoyo Digimatic or Digimatic 2 Type A, B, C, D, E, F, G.
- > Includes U-WAVEPAK Setup Software.

Order No.	Description	List	Promo
02AZD730G	U-WAVE-T/IP67 TYPE	\$220.00	\$198.00
02AZD880G	U-WAVE-T/BUZZER TYPE	\$220.00	\$198.00
02AZD810D	U-WAVE-R	\$499.00	\$449.10
02AZD790A	U-WAVE CONNECTING CABLE A	\$110.00	\$99.00
02AZD790B	U-WAVE CONNECTING CABLE B	\$110.00	\$99.00
02AZD790C	U-WAVE CONNECTING CABLE C	\$110.00	\$99.00
02AZD790D	U-WAVE CONNECTING CABLE D	\$110.00	\$99.00
02AZD790E	U-WAVE CONNECTING CABLE E	\$110.00	\$99.00
02AZD790F	U-WAVE CONNECTING CABLE F	\$110.00	\$99.00
02AZD790G	U-WAVE CONNECTING CABLE G	\$110.00	\$99.00





*Complimentary ground shipping for the 48 contiguous United States. Offer applies to orders placed April 19 through June 30, 2021. Mitutoyo America Corporation reserves the right to change or discontinue this offer at any time. This offer is void wherever prohibited or restricted by law. No cash value. For Alaska and Hawaii special rates apply. Contact us for details.

Complimentary shipping cannot be applied toward previously placed orders. Orders may only be shipped to a single address. If customer returns product, they are responsible for the shipping cost. Refer to our terms and conditions for further details.

High-Performance 2D Linear Height LH-600E

The Mitutoyo Linear Height LH-600E offers advanced performance for reliable and easy 2D measurement.

Measuring Range (stroke) 0–38" (24") / 0–972mm (600mm)

- > 0.1µm/1µinch resolution.
- > Excellent accuracy of $(1.1+0.6L/600)\mu\text{m}$ with 0.4µm repeatability.
- > Perpendicularity of 5µm and straightness of 4µm are guaranteed.
- > Pneumatic full/semi-floating system.
- > One-key operation for running a semi-automatic measurement.
- > Measure hole diameters, gap distances, and even 2D measurements such as diagonal center-to-center distances.
- > The origin can be set at the top of a surface plate, centerline, top or bottom surfaces, or peak top or bottom points on radii.

MeasurLink ENABLED
Data Management Software by Mitutoyo



518-351A-21

518-352A-21



VIDEO DEMO

Frequently Used Measurements

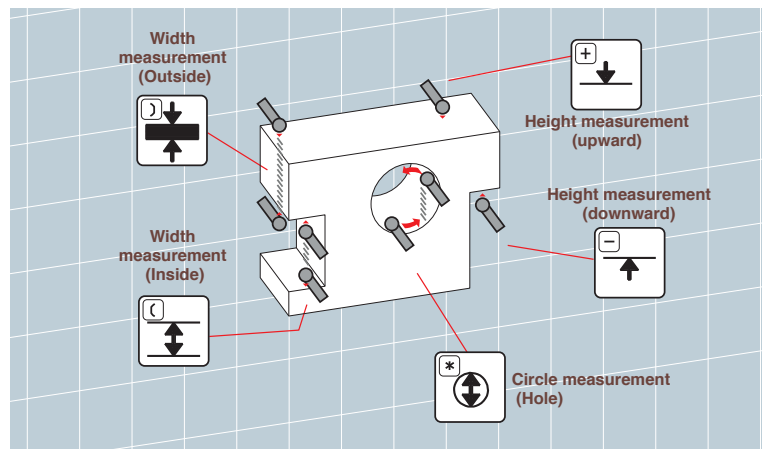

Screen Display & Printer Output Examples

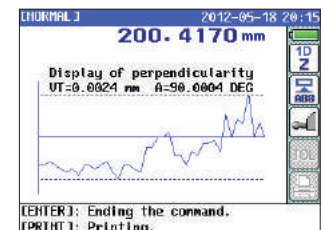
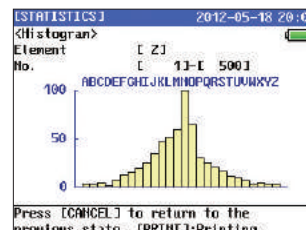
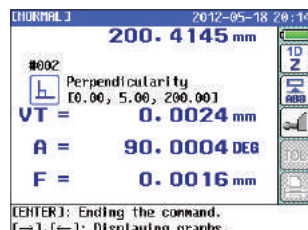
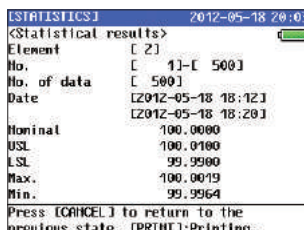

10% OFF PLUS Complimentary Shipping & Calibration

5% OFF Accessories



*Complimentary accredited calibration applies to orders placed April 19 through June 30, 2021. Mitutoyo America Corporation reserves the right to change or discontinue this offer at any time. This offer is void wherever prohibited or restricted by law. No cash value. Complimentary accredited calibration will be conducted prior to unit shipping and cannot be applied toward previously placed orders. Refer to our terms and conditions for further details.



*Complimentary ground shipping for the 48 contiguous United States. Offer applies to orders placed April 19 through June 30, 2021. Mitutoyo America Corporation reserves the right to change or discontinue this offer at any time. This offer is void wherever prohibited or restricted by law. No cash value. For Alaska and Hawaii special rates apply. Contact us for details. Complimentary shipping cannot be applied toward previously placed orders. Orders may only be shipped to a single address. If customer returns product, they are responsible for the shipping cost. Refer to our terms and conditions for further details.

Order No.	Base No.	Range (Stroke)	Resolution	Remarks	List	Promo
PROMO027	518-351A-21	0 - 977mm (600mm) 0 to 38" (24")	0.0001/0.001/0.01/0.1mm	—	\$8,480.00	\$7,632.00
PROMO028	518-352A-21		.000001/.00001/.0001/.001"(selectable)	w/power grip	\$8,990.00	\$8,091.00

Optional Accessories

Order No.	Description	List	Promo
12AAC072	DEPTH STYLUS FOR LH	\$198.00	\$188.10
12AAC073	TAPER STYLUS FOR LH	\$195.00	\$185.25
12AAA837	INDICATOR HOLDER (ACCEPTS 3/8" STEM)	\$144.00	\$136.80
12AAA793	HOLDER (LONG TYPE)	\$161.00	\$152.95
K650986	STYLI KIT M3 LINEAR HEIGHT	\$500.00	\$475.00
12AAA807	RS-232C CONNECTING CABLE (2M) LH	\$55.95	\$53.15
64AAB532	USB 2.0 RS-232 SERIAL ADAPTER W/LED INDICATORS	\$61.55	\$58.47
12AAA879	SAMPLE WORKPIECE FOR LH-600B	\$311.00	\$295.45
226118	SHANK WITH M3 THREAD SCREW	\$126.00	\$119.70
957265	20MM DIA. DISK STYLUS FOR LINEAR HEIGHT	\$381.00	\$361.95
957264	14MM DIA. DISK STYLUS FOR LINEAR HEIGHT	\$310.00	\$294.50
12AAF669	10PI BALL CONTACT POINT(COAXIAL)	\$235.00	\$223.25
957261	2MM DIA. BALL STYLUS FOR LINEAR HEIGHT	\$211.00	\$200.45
517-714	GRAPLATE 36X48" GRADE AA	\$3,280.00	\$3,116.00
517-964	GRAPLATE STAND 36X48"	\$1,206.00	\$1,145.70
517-708	GRAPLATE 24X36" GRADE AA	\$1,709.00	\$1,623.55
517-956	GRAPLATE STAND 24X36"	\$1,023.00	\$971.85

Linear Height Styli Kit



K650986

Contents	Description	ø S	L
1x Part No. K681867	Adapter block		
1x Part No. K651223	Pin wrench ø 1.2 mm		
1x Part No. K651157	Extension steel M3		20
1x Part No. K651156	Extension steel M3		10
1x Part No. K651172	Disk stylus steel M3	12.7	33
1x Part No. K651151	Stylus steel-ruby M3	4	31
1x Part No. K651148	Stylus steel-ruby M3	3	21
1x Part No. K651147	Stylus steel-ruby M3	2	21
1x Part No. K651146	Stylus steel-ruby M3	1	21

12AAA837

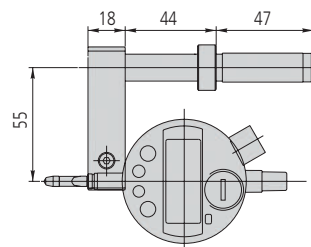

12AAC072





*Complimentary ground shipping for the 48 contiguous United States. Offer applies to orders placed April 19 through June 30, 2021. Mitutoyo America Corporation reserves the right to change or discontinue this offer at any time. This offer is void wherever prohibited or restricted by law. No cash value. For Alaska and Hawaii special rates apply. Contact us for details.

Complimentary shipping cannot be applied toward previously placed orders. Orders may only be shipped to a single address. If customer returns product, they are responsible for the shipping cost. Refer to our terms and conditions for further details.



ABSOLUTE 1D Height Gage QM-Height Series



- High-resolution ABSOLUTE linear encoder for position detection
- High-accuracy: $\pm(2.4 + 2.1L / 600)\mu\text{m}$
- Pneumatic flotation system / positioning grip allows for smooth movement along surface plate (select models)
- Large, stationary display panel with user-friendly icon control keys and GO/NO-GO LED indicator
- Digital and USB output: Supports Mitutoyo wireless SPC output
- Fully compatible with existing Mitutoyo Digimatic peripherals (SPC cables, U-WAVE wireless transmitters, multiplexers, etc.)
- **Battery life of 1200 hours in continuous use with four AA batteries, an improvement from 300 hours.**

GO/ \pm NG judgment by LED (red, orange, green) and measurement examples

- LEDs are activated at the time of tolerance judgment: green for GO, red for +NG, and orange for -NG. -NG, GO and +NG also appear on the LCD.



- Measure diameters, gap distances, center-to-center distances, and more
- Sub-display can show difference between current and previous measurement or distance from current measurement to origin
- The origin can be set at the top of a surface plate, centerline, or any top or bottom surface within its range



"d2" is the name for Mitutoyo Digimatic output compatible with up to 8 digits of I/O data.

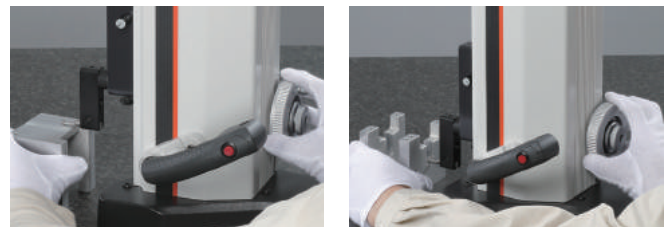

New d2 Digimatic and USB outputs

- Digimatic and USB ports are provided as standard. Using the U-WAVE-T measurement data wireless communication system enables instant transmission of measurement data to a PC via wireless communication which reduces manual input errors and improves data reliability and operational efficiency.



To install U-WAVE-T, separately purchase the optional mounting plate (02AZE990).



10% OFF PLUS Complimentary Shipping & Calibration

5% OFF Accessories

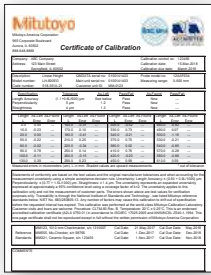

*Complimentary accredited calibration applies to orders placed April 19 through June 30, 2021. Mitutoyo America Corporation reserves the right to change or discontinue this offer at any time. This offer is void wherever prohibited or restricted by law. No cash value. Complimentary accredited calibration will be conducted prior to unit shipping and cannot be applied toward previously placed orders. Refer to our terms and conditions for further details.



*Complimentary ground shipping for the 48 contiguous United States. Offer applies to orders placed April 19 through June 30, 2021. Mitutoyo America Corporation reserves the right to change or discontinue this offer at any time. This offer is void wherever prohibited or restricted by law. No cash value. For Alaska and Hawaii special rates apply. Contact us for details. Complimentary shipping cannot be applied toward previously placed orders. Orders may only be shipped to a single address. If customer returns product, they are responsible for the shipping cost. Refer to our terms and conditions for further details.

Measurement Examples

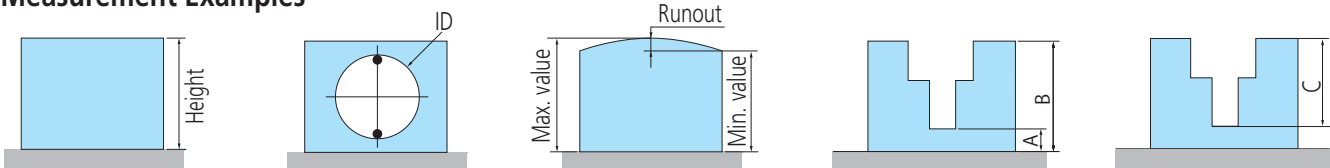

Part No.	Range	Resolution	Remarks	List	Promo
64PKA094BCAL	0 - 14" / 0 - 350mm	0.001mm / 0.0005mm / .00005" / .0001" (selectable)	Pneumatic Flotation System	\$3,990.00	\$3,591.00
64PKA095BCAL	0 - 24" / 0 - 600mm			\$4,490.00	\$4,041.00
64PKA129BCAL	0 - 14" / 0 - 350mm			\$4,490.00	\$4,041.00
64PKA130BCAL	0 - 24" / 0 - 600mm			\$4,990.00	\$4,491.00

Optional Accessories

Order No.	Description	List	Promo
12AAC072	DEPTH PROBE	\$198.00	\$188.10
12AAA837	INDICATOR HOLDER (ACCEPTS 3/8" STEM)	\$144.00	\$136.80
12AAA793	PROBE EXTENSION HOLDER (3.3" / 85mm)	\$161.00	\$152.95
226118	SHANK WITH M3 THREAD SCREW	\$126.00	\$119.70
957265	20MM DIA. DISK STYLUS FOR LINEAR HEIGHT	\$381.00	\$361.95
957264	14MM DIA. DISK STYLUS FOR LINEAR HEIGHT	\$310.00	\$294.50
12AAF669	10PI BALL CONTACT POINT(COAXIAL)	\$235.00	\$223.25
957261	2MM DIA. BALL STYLUS FOR LINEAR HEIGHT	\$211.00	\$200.45
517-814	GRAPLATE 36X48" GRADE A	\$2,794.00	\$2,654.30
517-964	GRAPLATE STAND 36X48"	\$1,206.00	\$1,145.70
517-808	GRAPLATE 24X36" GRADE A	\$1,457.00	\$1,384.15
517-956	GRAPLATE STAND 24X36"	\$1,023.00	\$971.85
06AFM380D	USB-ITN-D INPUT TOOL DIRECT CABLE	\$197.00	\$187.15
02AZD730G-D	U-WAVE TRANSMITTER W/ CONNECTING CABLE (D)	\$330.00	\$313.50
02AZD810D	U-WAVE-RECEIVER	\$499.00	\$449.10

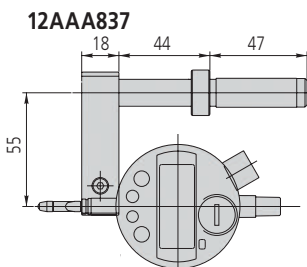

12AAC072



02AZD730G-D



02AZD810D



Surftest SJ-210 Packages

- > Large color LCD display
- > Easy-to-use buttons for quick operations
- > Displays measurement results, evaluation curves and waveform
- > Supports global industry standards
- > Password protect function prevents unintended operations
- > 16 languages supported



178-561-12A

MeasurLink ENABLED
Data Management Software by Mitutoyo



Order No	Description	List	Promo
64PKA226A	Calibration Package	\$2,946.00	\$2,430.00
178-561-12A	SJ-210 inch/mm 4mN (Standard Drive Unit)		
178-390	FREE EXTRA DETECTOR		
C178-602	50% off Calibrated specimen		

Order No	Description	List	Promo
64PKA227A	Data Collection Package	\$3,259.00	\$2,760.00
178-561-12A	SJ-210 inch/mm 4mN (Standard Drive Unit)		
02AZD730G	U-WAVE TRANSMITTER		
02AZD790D	U-WAVE connecting cable D		
02AZD810D	FREE U-WAVE RECEIVER		

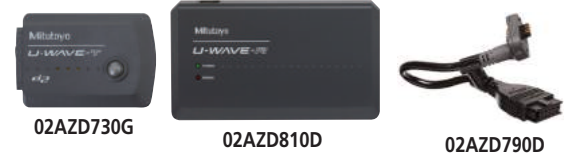

02AZD730G

02AZD810D

02AZD790D

Order No	Description	List	Promo
64PKA228A	Height Gage Package	\$3,572.00	\$2,890.00
178-561-12A	SJ-210 inch/mm 4mN (Standard Drive Unit)		
12AAA233	Height gage adapter (Inch)		
192-150	12" Dial height gage		



12AAA233

192-150

Enhanced power for making measurements on site

Charging is reduced approximately one quarter of the time compared with conventional models. The detector supports a variety of measurement orientations and can perform measurements up against a wall surface or while facing upward. When combined with optional accessories such as a height gage adapter, the detector can perform measurements in various orientations and settings.



Prices effective April 19 – June 30, 2021



Bench Top

Laser Scan Micrometer LSM-9506

- > Integrated display and measuring unit in one unit.
- > Statistical calculation mode.
- > RS-232C output, I/O interface and SPC output interface are standard.
- > Accuracy: .0001"

MeasurLink ENABLED
Data Management Software by Mitutoyo



544-116-1A

Order No	Range	Resolution	List	Promo
544-116-1A	.020" - 2.36"/0.5mm - 60mm	.000002" - .005"/0.00005 - 0.1mm	\$8,940.00	\$8,046.00

QUICKTOOL* is a free, downloadable software that makes programming the laser quick and easy.
*For use with customer-supplied PC and optional RS-232C cable.

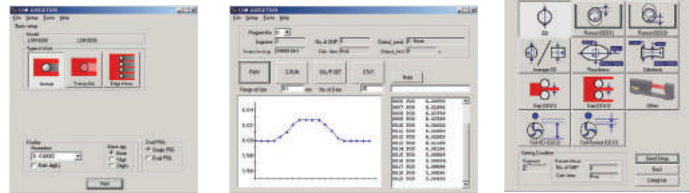

High-Accuracy Non-Contact Measuring Systems

- > Excellent accuracy: down to +/- 12 μinches
- > High-speed scanning capable: 3,200 scans per second.
- > Various ranges available for selecting the best laser for your application.
- > Statistical calculation mode.
- > Memory function allows storage of up to 100 programs.
- > Standard RS-232C output and I/O interface. Optional Digimatic output.



**FREE
LSM 6200
Display!**



UP TO 35% OFF

Order No	Model	Range Inch	Range mm	Repeatability	Accuracy	Scanning Rate	List	Promo
64PKA117	LSM-500S	.0002" - .08"	0.005~2mm	±0.03μm	±0.3μm	3,200 scans/sec	\$10,370.00	\$7,090.00
64PKA118	LSM-501S	.002" - .4"	0.05~10mm	±0.04μm	±0.5μm [†]	3,200 scans/sec	\$9,330.00	\$6,050.00
64PKA119	LSM-503S	.012" - 1.18"	0.3~30mm	±0.11μm	±1.0μm [†]	3,200 scans/sec	\$10,110.00	\$6,830.00
64PKA120	LSM-506S	.04" - 2.36"	1~60mm	±0.36μm	±3μm [†]	3,200 scans/sec	\$11,480.00	\$8,200.00
64PKA121	LSM-512S	.04" - 4.72"	1~120mm	±0.85μm	±6μm [†]	3,200 scans/sec	\$17,680.00	\$14,400.00
64PKA122	LSM-516S	.04" - 6.30"	1~160mm	±1.4μm	±7μm [†]	3,200 scans/sec	\$28,480.00	\$25,200.00

[†] Accuracy over entire range. Higher accuracies are possible over smaller ranges.

MeasurLink ENABLED
Data Management Software by Mitutoyo



QUICKTOOL* is free downloadable software that makes programming the LSM-6200 quick and easy.
*For use with customer-supplied PC and optional RS-232C cable.





Digimatic Quill Kit

Easy Installation, Fits Most Vertical Knee Mills

- > Easy-to-read LCD with resolution of .0005"/0.01mm. 0-6" travel.
- > Push-button controls for inch/mm, Zero-Set and On/Off.
- > Powered by a single SR-44 Battery which lasts about 1 year with normal use.
- > SPC Output for data transmission to data processors or a remote display.
- > ABS encoder.

MeasurLink ENABLED
Data Management Software by Mitutoyo

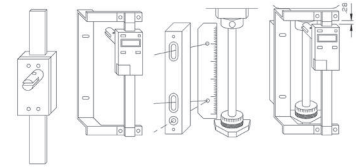
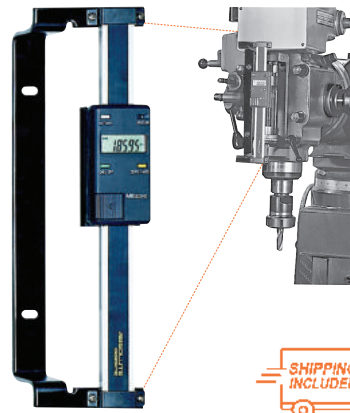

The Mitutoyo Quill Kit mounted on a vertical mill.

ABSOLUTE™



Order No.	Description	List	Promo
053906B	Digimatic Quill Kit complete with brackets & scale for Bridgeport Type machines.	\$310.00	\$294.50

ABSOLUTE Digimatic Scale Units

- > The Origin key allows setting of an absolute zero point to be used as reference in subsequent measurements. Once set, the ABS Digimatic Scale Unit is ready to show its true position whenever turned on, rather than 0.00" as with standard models.
- > The Zero/ABS key allows the display to be zero-set at any slider position along the beam for incremental comparison measurements. This key will also allow return to the absolute coordinate with a display of the true position from the origin point.
- > No rack, no pinion, no glass scale. Digimatic scale unit is safely embedded in the hardened stainless steel blade.
- > Horizontal or vertical face according to the scale mounting direction.
- > Multi-function types with diameter displaying function are also available for lathes. (Contact Mitutoyo.)
- > All units come with two mounting brackets, each located at either end of the scale.
- > With SPC data output.



ABSOLUTE™



Order No	Model	Range	Accuracy	Resolution	Type	List	Promo
572-210-30	SD-4"DX	0-4" / 0-100mm	.001" / 0.03mm	.0005" / 0.01mm	Horizontal single-function	\$235.00	\$223.25
572-211-30	SD-6"DX	0-6" / 0-150mm	.001" / 0.03mm	.0005" / 0.01mm	Horizontal single-function	\$249.00	\$236.55
572-212-30	SD-8"DX	0-8" / 0-200mm	.001" / 0.03mm	.0005" / 0.01mm	Horizontal single-function	\$290.00	\$275.50
572-213-10	SD-12"D	0-12" / 0-300mm	.002" / 0.04mm	.0005" / 0.01mm	Horizontal single-function	\$559.00	\$531.05
572-310-10	SDV-6"D	0-4" / 0-100mm	.001" / 0.03mm	.0005" / 0.01mm	Vertical single function	\$260.00	\$247.00
572-311-10	SDV-6"D	0-6" / 0-150mm	.001" / 0.03mm	.0005" / 0.01mm	Vertical single-function	\$276.00	\$262.20
572-312-10	SDV-8"D	0-8" / 0-200mm	.001" / 0.03mm	.0005" / 0.01mm	Vertical single function	\$320.00	\$304.00
572-313-10	SDV-12"D	0-12" / 0-300mm	.002" / 0.04mm	.0005" / 0.01mm	Vertical single function	\$616.00	\$585.20

MeasurLink ENABLED
Data Management Software by Mitutoyo

Applications

Machine table position

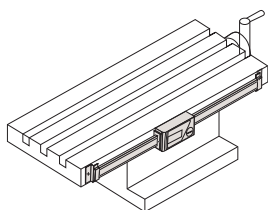

Drilling machine stroke position

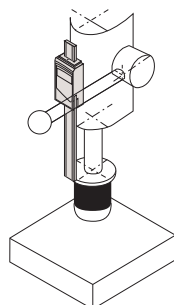

Focus setting on optical instruments

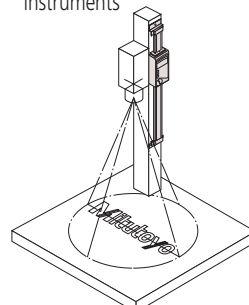

Special Applications

As a measurement jig for outdoor use (SD-G)

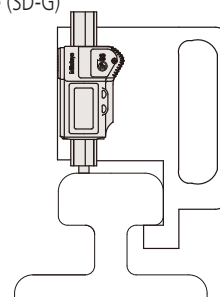

Detector head mechanism

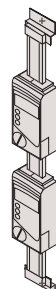



Mitutoyo Digital Readout Packages

Mounting Hardware Included on all machine retrofit packages

All DRO Packages Include:

- > KA-200 Counter
- > KA-200 Counter tray/arm kit
- > High Resolution Linear Scales (down to .0001" or better!)
- > Bracket Kit(s)



SAVE
\$200
PER PACKAGE

MeasurLink ENABLED
Data Management Software by Mitutoyo

Package Part No.	Description	X Travel	Y Travel	Z Travel	X Axis Type	Y Axis Type	Z Axis Type	List	Promo
64PKA058A	12" X 30" DRO Mill Package	30"	12"		AT715	AT715		\$1,490.00	\$1,290.00
64PKA059A	12" X 36" DRO Mill Package	36"	12"		AT715	AT715		\$1,490.00	\$1,290.00
64PKA060A	14" X 30" DRO Mill Package	30"	14"		AT715	AT715		\$1,490.00	\$1,290.00
64PKA062A	16" X 36" DRO Mill Package	36"	16"		AT715	AT715		\$1,490.00	\$1,290.00
64PKA063A	16" X 40" DRO Mill Package	40"	16"		AT715	AT715		\$1,490.00	\$1,290.00
64PKA035A	6" X 28" Lathe Package	6"		28"	AT116		AT715	\$1,450.00	\$1,250.00
64PKA039A	8" X 40" Lathe Package	8"		40"	AT116		AT715	\$1,450.00	\$1,250.00
64PKA042A	10" X 40" Lathe Package	10"		40"	AT116		AT715	\$1,450.00	\$1,250.00
64PKA046A	12" X 40" Lathe Package	12"		40"	AT116		AT715	\$1,450.00	\$1,250.00
64PKA050A	12" X 60" Lathe Package	12"		60"	AT116		AT715	\$1,650.00	\$1,450.00
64PKA052A	14" X 40" Lathe Package	14"		40"	AT116		AT715	\$1,450.00	\$1,250.00
64PKA057A	16" X 60" Lathe Package	16"		60"	AT116		AT715	\$1,650.00	\$1,450.00
64PKA026A	6" X 12" Grinder Package	6"		12"	AT116		AT116	\$1,620.00	\$1,420.00
64PKA028A	8" X 12" Grinder Package	8"		12"	AT116		AT116	\$1,620.00	\$1,420.00
64PKA029A	8" X 14" Grinder Package	8"		14"	AT116		AT116	\$1,620.00	\$1,420.00

Other packages and kits are available for mills, lathes, grinders and custom machines and applications. Contact your local distributor for details.

Durometers (Digital and Analog) For Rubber and Plastic Hardness Testing

- > Durometers are suitable for testing natural rubber, neoprene, polyesters, PVC, leather, Thiokol, nitril, wax, vinyl, cellulose acetates, glass, polystyrol and other materials.



Compact Dial
811-336-10



Compact Digital
811-336-10

MeasurLink ENABLED
Data Management Software by Mitutoyo



Order No	Model	Scale	Display	Graduation	Range	Indenter	List	Promo
811-335-10	HH-335	Shore A	Analog	1.0	10~90	Blunt Taper	\$599.00	\$569.05
811-336-10	HH-336	Shore A	Digital	0.5	10~90	Blunt Taper	\$1,280.00	\$1,216.00
811-337-10	HH-337	Shore D	Analog	1.0	20~90	Sharp Point	\$599.00	\$569.05
811-338-10	HH-338	Shore D	Digital	0.5	20~90	Sharp Point	\$1,280.00	\$1,216.00

HH-411 Hardmatic

Rebound Leeb portable hardness tester featuring reproducibility and ease of operation on large parts. It is lightweight and can be carried into the shop or out in the field.

MeasurLink ENABLED
Data Management Software by Mitutoyo



Order No.	Type	List	Promo
810-298-10	HH-411 Hardmatic	\$3,990.00	\$3,790.50



www.mitutoyo.com

MF / MF-U Measuring Microscopes with Metlogix M2 Software and Touch-Screen Tablet

Featuring M2 geometric measuring display

- > Highest measuring accuracy in its class
- > Stage travel range up to 400mm x 200mm / 16in x 8in
- > Quick release mechanism and zero-set buttons on stage controls increase operability when working larger workpieces
- > Easy to use all-in-one PC Touch Screen Display
- > M2 Geometric 2D Measurement Software
- > Camera port is standard on all models
- > Wide range of objectives available from 1x to 100x
- > M2 Retrofit package available for D generation MF and MF-U microscopes
- > Microscope packages with M2 software and tablet are listed below



Order No.	Description	List
176-861-10PK1	MF-A1010D, LED, MONOCULAR TUBE, WITH M2 SYSTEM	\$19,500.00
176-863-10PK1	MF-A2017D, LED, MONOCULAR TUBE, WITH M2 SYSTEM	\$25,500.00
176-861-10PK2	MF-A1010D, LED, BINOCULAR TUBE, WITH M2 SYSTEM	\$20,500.00
176-863-10PK2	MF-A2017D, LED, BINOCULAR TUBE, WITH M2 SYSTEM	\$26,500.00
64PKA234	M2 Retrofit Kit for MF/MF-U Microscopes M2 2D Data Processing Unit with software and hardware including a tablet PC. Also includes installation and calibration on the customer's existing MF or MF-U Microscope	\$3,900.00

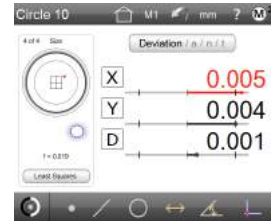

Geometric tolerancing
Measure features, set nominals, apply tolerances and view deviation results with only a few quick clicks.



Reports Flexibility for report contents and formatting allows for full customization of the data format, header information, and header and footer graphics.

MF Measuring Microscopes

- > Observation with a crisp and high-resolution erect image and a wide field of view.
- > Measuring accuracy that is highest in its class (and conforms to JIS B 7153).
- > Included 3x objective and binocular eyetube.
- > Illumination unit (reflected/transmitted) selectable from a high-intensity LED.
- > Quick-release mechanism useful for moving the stage quickly when measuring workpieces that are large in size or quantity.
- > Dedicated camera port allows for simultaneous eyepiece and digital observation.

Model No. (XY stage size)	MF-A1010D
XY stage travel range	4 x 4" / 100 x 100mm
Z-axis travel range	6" / 150mm
Focusing method	Manual focusing (Coarse focusing: 30mm/rev., Fine focusing: 0.2mm/rev.)
Measurement method	Linear encoder (2-axis model: X / Y-axis, 3-axis model: X / Y / Z-axis)
Resolution (switchable)	.0001" / .00005" / .00001" (0.001mm / 0.0005mm / 0.0001mm)
Measuring accuracy (at 20°C)	XY-axis: (2.2+0.02L)µm, L = Measuring length (mm) when not loaded, JIS B 7153
Indication accuracy (at 20°C)	Z-axis: (5+0.04L)µm, L = Measuring length (mm), (MF-B type)
Floating function	X and Y axes with Quick-release mechanism
XY stage top size	11 x 11" / 280 x 280mm
Effective glass size	7 x 7" / 180 x 180mm
Max. stage loading	22lbs / 10kg
Max. workpiece height	6" / 150mm

10% OFF ALL MF & MF-U MICROSCOPES



176-861-10

MeasurLink ENABLED
Data Management Software by Mitutoyo

Sample Package

Order No	Description	List	Promo
64PKA092A	MF-A1010D Package		
176-861-10	MF-A1010D	\$18,960.00	\$17,064.00
176-445A	LED Illumination unit (MF)		
176-393	Binocular Tube		



Trinocular Stereo Microscope MSM-414TL

- > Continuous 1X - 4X magnification.
- > Image always in focus throughout zoom range.
- > Crisp, erect images with high resolution and excellent stereoscopic effect.
- > Stereo-tube can be rotated a full 360° for viewing at any angle.
- > Bilateral zoom control knob adds convenience and increases operator efficiency.
- > Diopter adjustment for both eyepieces.

Model	MSM-414TL
Order No.	377-974A
Optical tube	Trinocular
Total magnification	10X - 40X
Eyepiece	10X (377-016)
Objective	1X - 4X
Working distance	80mm
Field of view	20mm - 5mm
Dimensions	H=13.2" x W=6.7" x D=9.3"
Mass	13.2 lbs (6kg)



Order No.	Description	List	Promo
377-974A	MSM-414TL Stereo Microscope	\$1,380.00	\$1,311.00

Optional Accessories

377-481	C-mount Video Adapter for MSM-414TL	\$53.85
64AAB526	Moticam 1080 Digital Camera w/ software, 2.0MP, HDMI/USB output	\$1,250.00



Camera with software for digital viewing

TM Toolmakers' Microscopes



- > Adjustable illumination intensity.
- > Angle measurement is performed easily by turning the angle scale disc to align the cross-hair reticle with the workpiece image.
- > Includes standard accessories create an overall magnification of 30X. Magnifications can be changed from 20 - 200X by using optional objectives and/or eyepieces.
- > .000050" resolution digimatic micrometer heads included.



Conventional illumination



Newly designed LED illumination

MeasurLink ENABLED
Data Management Software by Mitutoyo

10% OFF



**TM-A505B
176-820A**

Model No.		TM-A505B	TM-A1005B
Order No.		176-820A	176-821A
Eyepiece		Standard accessory: 15X (field number: 13), Options: 10X, 20X	
Objective lens		Standard accessory: 2X, Options: 5X, 10X	
Microscope head	Maximum height of workpiece	4.53" / 115mm	4.21" / 107mm
	Illumination unit	Stepless brightness adjustment, White LED light source, with green filter	
Cross-travel stage	Measuring range	2" x 2" / 50x50mm	4" x 2" / 100x50mm (An optional 2" / 50mm gage block is required to cover full range. A CERA block is recommended.)
	Usable area of the stage glass	3.8" x 3.8" / 96x96mm	6" x 3.8" / 154x96mm
	Maximum stage glass loading	11 lbs. / 5kg	
Linear measurement method		Micrometer heads included	
	List	\$5,590.00	\$7,290.00
	Promo	\$5,031.00	\$6,561.00

PJ-Plus with M2 2D Processor Packages

The Mitutoyo PJ-Plus is a new series of profile projectors that utilize LED lighting and provides reliable measurements in manufacturing site environments. The PJ-Plus provides stable dimension and angle measurements in harsher environments conventional models can't handle, such as manufacturing and processing lines.

- > LED illumination
- > Stepless illumination adjustment
- > Improved durability
- > Intuitive operation
- > Built-in digital XY counter
- > Available with M2 or QM-Data 2D processor

MeasurLink[™] ENABLED
Data Management Software by Mitutoyo



New Optional Ring Light

Part number 172-502 is a new optional ring light for 10x and 20x objectives*



Example of attaching the LED circular illuminator on the PJ-Plus



* Damping ring 12AAX044 is required for connecting ring light to a 20x objective.

Optional M2 2D Processor

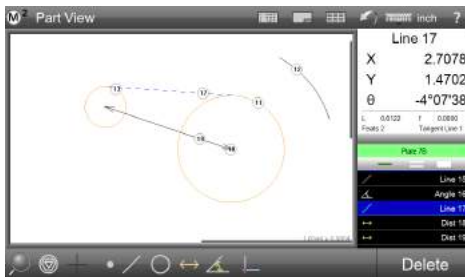

Graphics-based "Part View" constructions

Generate popular construction types, like Distances and Tangent Lines, from within the graphical part view.

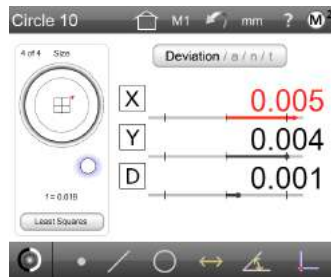

Geometric tolerancing

Measure features, set nominals, apply tolerances and view deviation results with only a few quick clicks.

An XY axis digital counter is built into the PJ-Plus



Refer to Bulletin No. 2300 for more information

Optional Stand



Part number 64PMI167
STAND FOR PJ-PLUS 24.4"x20"x32"
(CHARCOAL GRAY, RAL7016 RTM)
List Price: \$688.00

Order No.	Description	Edge Detection	List
302-801-10PKA1	PJ Plus 4 x 4 stage	Yes	\$16,300
302-801-10PKA2	PJ Plus 4 x 4 stage	No	\$15,050
302-802-10PKA1	PJ-Plus 8 x 4 Stage	Yes	\$19,100
302-802-10PKA2	PJ-Plus 8 x 4 Stage	No	\$17,850
302-801-10	PJ-P1010A 4" x 4" / 100mm x 100mm		\$10,800
302-802-10	PJ-P2010A 8" x 4" / 200mm x 100mm		\$13,600
172-502	Ring Light for 10X & 20X Objectives		\$3,450

The PJ-Plus is available in packages with the Metlogix M2 software, touch screen tablet with or without edge detection. Mitutoyo installation and calibration is included with the purchase of one of the packages.



PH-3515 Profile Projector and 2D Processor Packages

Heavy-Duty, Bench-Top Model with Horizontal Optical System featuring touch screen M2 geometric measuring display

- > ø14" Screen, Horizontal Projector.
- > 10" x 6" Travel T Slot table for accessories.
- > Linear Glass Scales for accurate measurement Profile and Fiber Optic Surface Illumination.
- > Easy to use all-in-one PC Touch Screen.
- > M2 Geometric 2D Measurement Software.
- > Optional Edge Detection.
- > Digital built-in angle counter.

MeasurLink[®] ENABLED
Data Management Software by Mitutoyo

Order No.	Description	List
64PKA088A*	PH-3515F Profile Projector w/QM Data (Arm Mount)	\$13,500.00
64PKA089B	PH-3515F Profile Projector w/KA counter & tray	\$11,600.00
64AAB176	PH-3515 Stand (optional)	\$687.00
64PKA165	PH-3515 PROFILE PROJECTOR - WITH OPTICAL EDGE DETECTION AND TOUCH SCREEN M2 GEOMETRIC DISPLAY	\$15,900.00
64PKA166	PH-3515 PROFILE PROJECTOR - WITH TOUCH SCREEN M2 GEOMETRIC DISPLAY	\$14,500.00

(Includes installation and A2LA accredited calibration)

*12AAE671 and 332-151 (Optoeye-200 Edge detection system) must be sold together as an option

PJ-H30 Vertical Profile Projector

- > Newly designed optical system with high NA lenses provides drastically brighter and clearer screen images during surface illumination.
- > The three-lens mounting turret includes a 10X lens as standard. Four types of projection lenses (5X, 20X, 50X, 100X) are available.

MeasurLink[®] ENABLED
Data Management Software by Mitutoyo



PJ-H30A3017B



Order No.	Description	XY Travel	List
303-712-1A	PJ-H30A1010B	4 x 4" /100x100mm	\$23,100.00
303-713-1A	PJ-H30A2010B	8 x 4" /200x100mm	\$28,200.00
303-714-1A	PJ-H30A2017B	8 x 6.7" /200x170mm	\$33,300.00
303-715-1A	PJ-H30A3017B	12 x 6.7" /300x170mm	\$38,400.00
* 303-732-1A	PJ-H30D1010B	4 x 4" /100x100mm	\$28,200.00
* 303-733-1A	PJ-H30D2010B	8 x 4" /200x100mm	\$33,300.00
* 303-734-1A	PJ-H30D2017B	8 x 6.7" /200x170mm	\$38,400.00
* 303-735-1A	PJ-H30D3017B	12 x 6.7" /300x170mm	\$43,600.00

* Built-in edge detection and power focus



Optional Accessories

Order No.	Description	List
264-156A	QM-Data200 (Arm-Mount Model)	\$2,720.00
332-151	Optoeye-200	\$1,650.00
12AAE671	Attachment (A) for Optoeye-200 for PH-3515, PJ-H30	\$40.80
174-183A	KA 200 Counter	\$587.00
64AAB176	Stand for PH-3515	\$687.00
172-269	MACHINE STAND FOR PJ-H SERIES	\$1,660.00

* Attachment A and 332-151 (Optoeye-200 Edge detection system) must be sold together as an option

* PJ-H30 requires 12AAG982 for 264-156A *174-183A can be used with stand 64AAB149

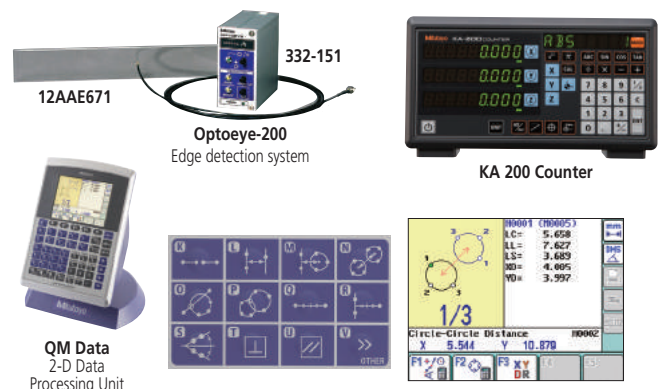

Calibrated Tools

Turnaround Time

Normally our laboratories maintain a turnaround time of 2 weeks.

Express Service

5 day and 1 day RUSH service is available for an additional fee.



Coolant-Proof Calipers



- > Sealed housing is IP-67 rated, meaning it's immune to the coolants, dirt, grit and chips found in many manufacturing environments.
- > Easy to use - no need to wipe or clean the scale.
- > .0005"/0.01mm resolution with $\pm .001$ " accuracy.
- > Automatic power-on/off.

MeasurLink ENABLED
Data Management Software by Mitutoyo

Digimatic Caliper

- > AOS Electromagnetic inductive sensor improves environmental resistance against dirt, water and oil.
- > A battery life of approximately 3.5 years has been achieved under normal use through the adoption of Mitutoyo's ABSOLUTE scale.
- > The slider configuration features an ergonomic, thumb-friendly shape.
- > Step-measurement capable.
- > The data output function allows integration into Statistical Process Control and measurement systems.
- > Display character height: 9mm
- > AOS applies to 4", 6" and 8" models
- > Resolution: .0005"/0.01mm



www.mitutoyo.com/aoscd
VIDEO DEMO

ABSOLUTE AOS
DIGIMATIC
AOS: Advanced Onsite Sensor

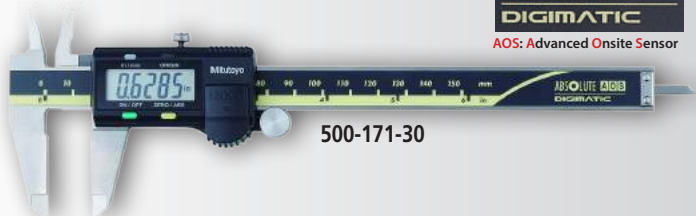

500-171-30

Digimatic Carbon Fiber Caliper



552-314-10

IP66 **SPC** **ABSOLUTE**
Absolute System Powered by MITUTOYO

MeasurLink ENABLED
Data Management Software by Mitutoyo

Order No.	Range	Accuracy	Resolution	List	Promo
552-312-10CAL	0(0.504")-18"	+/--.002"	.0005"/0.01mm	\$1,028.00	\$925.20
552-313-10CAL	0(0.504")-24"	+/--.002"	.0005"/0.01mm	\$1,169.00	\$1,052.10
552-314-10CAL	0(0.004")-40"	+/--.002"	.0005"/0.01mm	\$2,069.00	\$1,862.10
552-315-10CAL	0(0.004")-60"	+/--.004"	.0005"/0.01mm	\$2,469.00	\$2,222.10
552-316-10CAL	0(0.004")-80"	+/--.005"	.0005"/0.01mm	\$3,844.00	\$3,459.60

SPC cable - 1m: 05CZA624 2m: 05CZA625

Order No.	Range	List	Promo
Non-Output Style			
500-752-20CAL	0-6"/0-150mm	\$250.00	\$225.00
500-753-20CAL	0-8"/0-200mm	\$329.00	\$296.10
500-763-20CAL	0-8"/0-200mm	\$362.00	\$325.80
500-764-20CAL*	0-12"/0-30mm	\$600.00	\$540.00
500-754-20CAL*	0-12"/0-30mm	\$546.00	\$491.40
SPC Output Style			
500-762-20CAL	0-6"/0-150mm	\$290.00	\$261.00
500-733-20CAL	0-6"/0-150mm	\$405.00	\$364.50
500-734-20CAL	0-8"/0-200mm	\$495.00	\$445.50
500-736-20CAL	0-8"/0-200mm	\$411.00	\$369.90
500-737-20CAL	0-6"/0-150mm	\$446.00	\$401.40

* $\pm .0015$ " accuracy

SPC cable - 1m: 05CZA624 2m: 05CZA625

SPC **ABSOLUTE**
Absolute System Powered by MITUTOYO

MeasurLink ENABLED
Data Management Software by Mitutoyo

Order No.	Range	Remarks	List	Promo
No SPC Output Style				
500-195-30CAL	0-4"/0-100mm	.075" round depth bar	\$181.00	\$162.90
500-196-30CAL	0-6"/0-150mm		\$196.00	\$176.40
500-197-30CAL	0-8"/0-200mm		\$272.00	\$244.80
500-193-30CAL	0-12"/0-300mm		\$511.00	\$459.90
With SPC Output Style				
500-170-30CAL	0-4"/0-100mm	.075" round depth bar	\$210.00	\$189.00
500-171-30CAL	0-6"/0-150mm		\$223.00	\$200.70
500-172-30CAL	0-8"/0-200mm		\$289.00	\$260.10
500-173-30CAL	0-12"/0-300mm		\$588.00	\$529.20
500-505-10CAL	0-18"/0-450mm	without thumb roller	\$897.00	\$807.30
500-506-10CAL	0-24"/0-600mm	without thumb roller	\$1,006.00	\$905.40
500-507-10CAL	0-40"/0-1000mm	without thumb roller	\$1,909.00	\$1,718.10

SPC cable with data switch - 1m: 959149 2m: 959150

- > Lightweight Digimatic Calipers that employ CFRP (Carbon Fiber Reinforced Plastics) in the beam and jaws.
- > Highly durable and easy to handle.
- > Direct readout of ID measurements from the LCD. (Offset value can be set easily by pressing the Offset key.)
- > Preset function for setting a desired starting point.
- > With SPC data output.
- > Special models available with ceramic jaws which are suitable for measuring abrasive and magnetic products.
- > Can be used in workshop conditions exposed to coolant, water, dust or oil.
- > Incorporates ABSOLUTE measurement system.
- > Automatic power-on/off.

Dial Calipers

- > Smooth sliding with high shock protection.
- > Lock screw for dial bezel and for holding the sliding jaw position.
- > Can measure OD, ID, depth and steps.
- > Models available with carbide-tipped OD and ID jaws.
- > Graduations: .001"



Order No.	Range	Remarks	List	Promo
505-742CAL	6" .100"/rev.		\$160.00	\$144.00
505-738CAL	6" .100"/rev.	carbide-tipped jaws	\$248.00	\$223.20
505-740CAL	6" .200"/rev.		\$149.00	\$134.10
505-742-56CAL	6" .100"/rev.	Black dial face	\$160.00	\$144.00
505-737CAL	8" .100"/rev.		\$302.00	\$271.80
505-743CAL	8" .100"/rev.		\$223.00	\$200.70
505-746CAL	12" .100/rev		\$336.00	\$302.40
505-749CAL	12" .200/rev		\$316.00	\$284.40

Quick-Mini Thickness Gage



- > A compact thickness gage is suited for quick inspection of paper thickness, leather, wires, plastic parts, etc. The digital display provides error-free reading with 0.01mm / .0005" resolution.
- > Measuring force less than 2N.
- > Notifications for:
 - Low battery voltage
 - Scale surface contamination



Order No.	Range	Accuracy	Resolution	List	Promo
700-118-30CAL	0 - .5"/0 - 12.7mm	±.001"	.0005" / 0.01mm	\$209.00	\$188.10

Digimatic Thickness Gages

> Thickness Gages offer a quick and efficient means of inspection with their convenient grip handle, thumb trigger and spring-loaded spindle. Models with various dimensions are also available.

> With SPC output.



Order No.	Range	Resolution	Remarks	List	Promo
547-400SCAL	0-.47"/0-12mm	.00005"/0.001mm	High-Accuracy	\$917.00	\$825.30
547-500SCAL	0-.47"/0-12mm	.0005"/0.01mm	Standard Depth	\$351.00	\$315.90
547-520SCAL	0-.47"/0-12mm	.0005"/0.01mm	Throat Depth: 4.7"	\$374.00	\$336.60



Dial Thickness Gages

Thickness Gages offer a quick and efficient means of inspection with a convenient grip handle, thumb trigger and spring-loaded spindle. The various models cover a range of applications.

> Extremely high wear-resistant CERA contacts



VIDEO DEMO

Order No	Range	Graduation	Accuracy	Force	Remarks	List	Promo
7326SCAL	0 - .05"	.0001"	±.0002"	1.4N or less	Fine dial reading, ceramic spindle/anvil	\$269.00	\$242.10
7300SCAL	0 - .5"	.001"	±.001"	1.4N or less	Standard, ceramic spindle/anvil	\$179.00	\$161.10
7304SCAL	0 - 1"	.001"	±.002"	2.0N or less	Standard, ceramic spindle/anvil	\$207.00	\$186.30

Calibrated Tools

Turnaround Time

Normally our laboratories maintain a turnaround time of 2 weeks.

Express Service

5 day and 1 day RUSH service is available for an additional fee.



Digimatic Micrometer

- > Electromagnetic ABSOLUTE sensor - higher resistance to environmental conditions such as dirt, oil and water, which can cause false readings.
- > Ratchet thimble on select models improves one-hand operability.
- > Anti-slip finish for better grip while taking measurements.
- > Long battery life – 2.4 years under normal operation.
- > Fully compatible with existing Mitutoyo Digimatic peripherals (SPC Cables, U-WAVE wireless transmitters, DP1-VA, etc.) – SPC output-enabled IP65 models.
- > Function-lock system prevents inadvertent setting changes.



IP65



www.mitutoyo.com/MDC
VIDEO DEMO



COOLANT PROOF™

MeasurLink™ ENABLED
Data Management Software by Mitutoyo

Order No.	Range	Resolution	Remarks	List	Promo
293-330-30CAL*	0-1"/0-25.4mm	.00005"/0.001mm	Ratchet Stop	\$273.00	\$245.70
293-340-30CAL	0-1"/0-25.4mm	.00005"/0.001mm	Ratchet Stop	\$219.00	\$197.10
293-344-30CAL	0-1"/0-25.4mm	.00005"/0.001mm	Ratchet Thimble	\$219.00	\$197.10
293-349-30CAL	0-1"/0-25.4mm	.0001"/0.001mm	Ratchet Thimble, tenths reading	\$219.00	\$197.10
293-348-30CAL	0-1"/0-25.4mm	.00005"/0.001mm	Friction Thimble	\$219.00	\$197.10
293-331-30CAL*	1-2"/25.4-50.8mm	.00005"/0.001mm	Ratchet Stop w/Standard	\$331.00	\$297.90
293-341-30CAL	1-2"/25.4-50.8mm	.00005"/0.001mm	Ratchet Stop w/Standard	\$291.00	\$261.90
293-345-30CAL	1-2"/25.4-50.8mm	.00005"/0.001mm	Ratchet Thimble w/Standard	\$291.00	\$261.90
293-346-30CAL	2-3"/50.8-76.2mm	.00005"/0.001mm	Ratchet Thimble w/ Standard	\$370.00	\$333.00
293-334-30CAL*	0-1"/0-25.4mm	.00005"/0.001mm	Ratchet Thimble	\$291.00	\$261.90
293-335-30CAL*	0-1"/0-25.4mm	.00005"/0.001mm	Friction Thimble	\$273.00	\$245.70

*with SPC Output

SPC cable with data switch – 1m: 05CZA662 2m: 05CZA663



MDC-Lite Micrometer

- > Simple operation— zero set and in/mm (inch/metric models only) keys.
- > A ratchet stop or friction thimble for a constant measuring force.
- > Measurement readout with large LCD characters.
- > No spindle clamp. No data output.

Order No.	Range	Resolution	Remarks	List	Promo
293-831-30CAL	0 - 1" / 0 - 25.4mm	.00005" / 0.001mm	Ratchet Stop	\$181.00	\$162.90
293-832-30CAL	0 - 1" / 0 - 25.4mm	.00005" / 0.001mm	Friction Thimble	\$191.00	\$171.90



Mechanical Counter Micrometer

- > Mechanical digit counter with .001" reading for quick and error-free reading*
- > Friction Thimble



Order No	Range	Graduation	List	Promo
193-211CAL	0-1"	.0001"*	\$218.00	\$196.20

*.0001" reading is obtained with vernier.

Chrome Frame Micrometer

- > Satin chrome-finished frame, tapered (on the anvil side) for hard-to-reach places.



Order No	Range	Graduation	Accuracy	List	Promo
With Ratchet Stop					
101-113CAL	0-1"	.0001"	±.0001"	\$171.00	\$153.90

Prices effective April 19 – June 30, 2021

ID-S Digimatic Indicators

- > Employing the ABSOLUTE linear encoder, the ID-S always displays the spindle Absolute Position from the origin at power-on. Also, unlimited response speed eliminates overspeed errors.
- > Dust/Water protection level: IP42 (IP53: **543-795B, 543-796B**)
- > SPC data output.

ABSOLUTE

SPC

MeasurLink ENABLED
Data Management Software by Mitutoyo



Order No.	Resolution	Range	Accuracy	Measuring force	Remarks	List	Promo
Stem dia. 3/8", #4-48 UNF Thread							
543-783CAL	.0005"/0.01mm	.5" / 12.7mm	±.0010"	1.5N or less	w/ lug back	\$243.00	\$218.70
543-783BCAL	.0005"/0.01mm	.5" / 12.7mm	±.0010"	1.5N or less	w/ flat-back	\$243.00	\$218.70
Stem ø 8mm, M2.5 x 0.45 Thread							
543-782CAL	.0005"/0.01mm	.5" / 12.7mm	±.001"	1.5N or less	w/ lug back	\$243.00	\$218.70
543-782BCAL	.0005"/0.01mm	.5" / 12.7mm	±.001"	1.5N or less	w/ flat-back	\$243.00	\$218.70

SPC cable – 1m: **905338** 2m: **905409**

ID-C Digimatic Indicators

- > Absolute Encoder ensures all settings and readings maintained for the life of the battery (even when the power is turned off).
- > Preset, zero set, inch/mm, +/- direction and GO/NO-GO functions.
- > Face rotates 330° for use at various angles.
- > Stem diameter: 3/8".
- > Protected from overspeed errors.
- > SPC output provided.
- > Average battery life 7,000 hours using SR-44 battery (938882).

MeasurLink ENABLED
Data Management Software by Mitutoyo

Order No.	Range	Remarks	List	Promo
.0005"/0.01mm Resolution				
543-402CAL	.500"/12.7mm	lug back	\$380.00	\$342.00
543-402BCAL	.500"/12.7mm	flat back	\$380.00	\$342.00
543-476BCAL	1"/25mm	flat back	\$529.00	\$476.10
543-496BCAL	2"/50mm	flat back	\$676.00	\$608.40
.00005"/.0001"/.0005"/0.001mm/0.01mm selectable resolutions				
543-472BCAL	1"/25mm	flat back	\$646.00	\$581.40

SPC cable – 1m: **905338** 2m: **905409**



SPC

ABSOLUTE

Now with multiplier function $f(x)=Ax$
(other models available with $Ax+B+Cx-1$ function.)

Filling Your Customers' Calibrated Tool Orders is Now Easier & Faster

Our New Product Numbering System & Open "Date Put Into Service" Certificate Simplifies the Purchasing & Inventory Control Process.

Mitutoyo America Corporation has an exciting new feature to make buying, inventorying and selling certified Mitutoyo Calibrated Products easier, faster and more efficient.

A comprehensive list of Mitutoyo Calibrated Products now come with a single, unique product number and bar code from our warehouse, and the products' certificates of calibration have an open Date Put Into Service for longer shelf life and better inventory control.

These changes provide many advantages for distributors and end users, including:

- Calibrated tools and instruments can be inventoried by distributors and shipped to customers much faster now, eliminating previous lead times with "made-to-order" calibrations on tools.

- Single, new product code number includes a CAL suffix (eg: 500-196-30CAL) and bar code helping to control and manage your inventory.
- Open Date Put Into Service is filled in by the end user when the measuring equipment is first used, providing longer shelf life for distributors and end users.
- Open Date Put Into Service also avoids "lost" certified calibration time while the tool is in inventory, shipping, and waiting on the customer's shelf to be put into service.
- All Calibrated Products have an ISO/IEC 17025 Accredited Certificate of Calibration packaged with the product, representing the best practice in calibration.
- Calibrations are performed at the Mitutoyo America Corporation A2LA Accredited Calibration Laboratory in Aurora, Illinois



<https://www.mitutoyo.com/news/filling-your-customers-calibrated-tool-orders-is-now-easier-faster/>



Mitutoyo America Corporation
965 Corporate Boulevard
Aurora, Illinois 60502
1-888-648-8869

Mitutoyo products are sold only through authorized distributors. To find an authorized Mitutoyo distributor near you, visit: www.mitutoyo.com/distributor-locator/

Note: All information regarding our products, and in particular the illustrations, drawings, dimensional and performance data contained in this printed matter as well as other technical data are to be regarded as approximate average values. We therefore reserve the right to make changes to the corresponding designs. The stated standards, similar technical regulations, descriptions and illustrations of the products were valid at the time of printing. In addition, the latest applicable version of our General Trading Conditions will apply. Only quotations submitted by ourselves may be regarded as definitive. Specifications are subject to change without notice.

Mitutoyo products are subject to US Export Administration Regulations (EAR). Re-export or relocation of our products may require prior approval by an appropriate governing authority.

Trademarks and Registrations

Designations used by companies to distinguish their products are often claimed as trademarks. In all instances where Mitutoyo America Corporation is aware of a claim, the product names appear in initial capital or all capital letters. The appropriate companies should be contacted for more complete trademark and registration information.

We reserve the right to change specifications and prices without notice. Not valid with any other offer or promotion, previous purchases. Please refer to terms and conditions for additional information. Domestic U.S. orders only.

© 2021 Mitutoyo America Corporation

0321-01 • FOR WEB ONLY • April 2021



SPRING PROMO 2021

PRECISION TOOLS & INSTRUMENTS

Effective April 19 through June 30, 2021

SPRING PROMO 2021

MeasurLink[®] ENABLED

Data Management Software by Mitutoyo

